

Schuppenauslage

Stream delivery

Sortie à nappe

Ersatzteilliste
Spare part list
Liste des pieces de rechange



ASP
66/82-2ME

Für künftige Verwendung aufbewahren!
Alterations reserved!
Sous réserve de modifications!

Art der Maschine: Type of machine: Type de machine:	Schuppenauslage Stream delivery Sortie à nappe
Ausführung: Model: Version:	ASP 66/82-2ME
Art des Dokumentes: Typ of document: Nature du document:	Ersatzteilliste Spare part list Liste des pieces de rechange
Hersteller: Manufacturer: Le fabricant:	MBO Maschinenbau Oppenweiler Binder GmbH & Co. KG Postfach 1169 71567 Oppenweiler DEUTSCHLAND Tel.: +49 7191 46 0 Fax: +49 7191 46 34 http://www.mbo-folder.com info@mbo-folder.com
Dateiname: Dateiname (en): Dateiname (fr):	ETL_ASP_66/82-2ME
Version: 1.1	Maschinen-Nr.: Machine No.: N° de la machine:
Stand: 19.06.2008 Date: Mise à jour:	Serien-Nr.: Serial-No.: N° de série:
Sprache: de Language: en Langue: fr	Sachbearbeiter: Herr Matzner responsible person: Document suivi par:

Änderungen vorbehalten!
Alterations reserved!
Sous réserve de modifications!

Kundendienstinformation

Halten Sie bei Ersatzteil-Bestellungen unbedingt die nachfolgenden Angaben bereit. Dies gewährleistet eine schnelle und fehlerfreie Auftragsbearbeitung.

<ul style="list-style-type: none">• Fabrikationsnummer• Seriennummer• Maschinentyp	Sie finden diese Angaben am Typenschild Ihrer Maschine.
<ul style="list-style-type: none">• Teilebezeichnung• Teilenummer• Dokumenten-Nummer	Sie entnehmen diese Informationen der Ersatzteilliste Ihrer Maschine.

Die ausführlichen Informationen dazu finden Sie direkt zu Beginn des Ersatzteilordners.

Service information

In case of spare part orders, it is necessary to keep the following information ready.

This guarantees a quick and error-free order processing.

<ul style="list-style-type: none">• Fabrication number• Serial number• Machine type	You will find these information on the type plate of your machine.
<ul style="list-style-type: none">• Part designation• Part number• Document number	You will find these information in the spare part list of your machine.

You will find the detailed information at the beginning of this spare part list.

Information service après-vente

En cas de commandes concernant des pièces de rechange, veuillez tenir les indications suivantes à votre disposition. Ainsi, un traitement rapide et sans fautes de la commande peut être garanti.

<ul style="list-style-type: none">• Numéro de fabrication• Numéro de série• Type de la machine	Vous trouvez cetttes indications à la plaque signalétique de votre machine.
<ul style="list-style-type: none">• Désignation d'article• Numéro d'article• Numéro de document	Veuillez prendre cetttes informations de la liste de pièces de rechange de votre machine.

Vous trouvez les informations détaillées au début de votre fichier de pièces de rechange.



Schuppenauslage
Stream delivery
Sortie à nappe

ETL_ASP_66/82-2ME

Version 1.1

7.0

Inhaltsverzeichnis
Contents
Index



2

Kapitel: Chapter.: Chapitre:	Bezeichnung	Designation	Désignation	Seite: Page: Page:
7.1	Grundgestell	Basic frame	Châssis de base	4
7.2	Presswalzenstation	Press roller station	Poste de rouleau de pression	10
7.3	Aufschuppband	Shingle tape	Bande à positionner en nappe	28
7.4	Auslauf	Outlet	Sortie	34
7.5	Markiereinrichtung	Marking device	Compteur-décaleur	40
7.6	Anbauteile Schaltkasten	Add-on parts control box	Pièces d'assemblage boîte de commande	48
7.7	Höheneinstellung Einlauf	Height adjustment infeed	Réglage en hauteur entrée	50
7.8	Lichtschranke am Einlauf	Light barrier at infeed	Barrière lumineuse au entrée	52
7.9	Lichtschranke Auslauf Presstation	Light barrier at outlet press station	Barrière lumineuse sortie de poste de pression	54
7.10	Sonderteile Navigator	Special parts Navigator	Pièces spécial Navigator	56

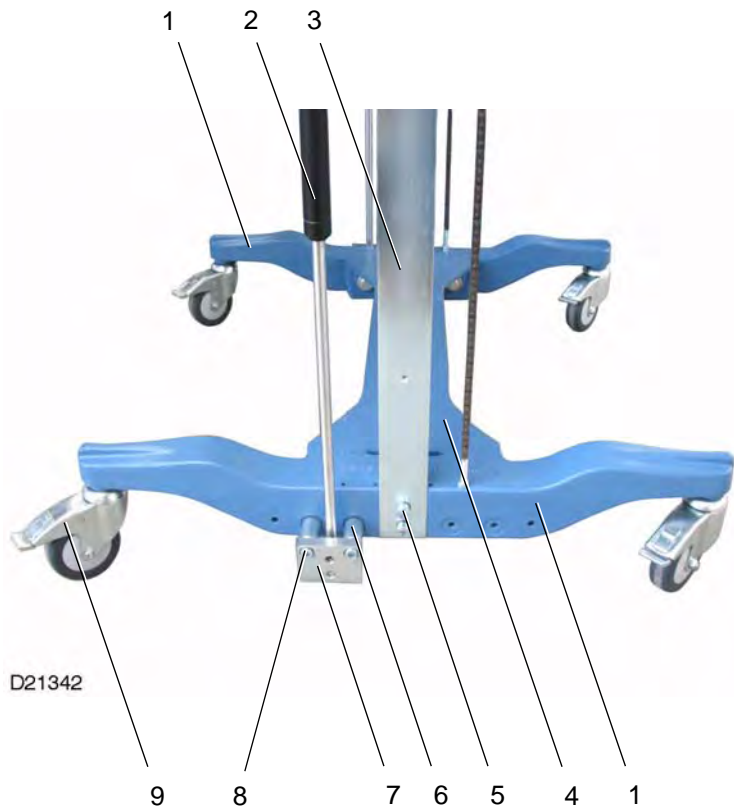

D21342

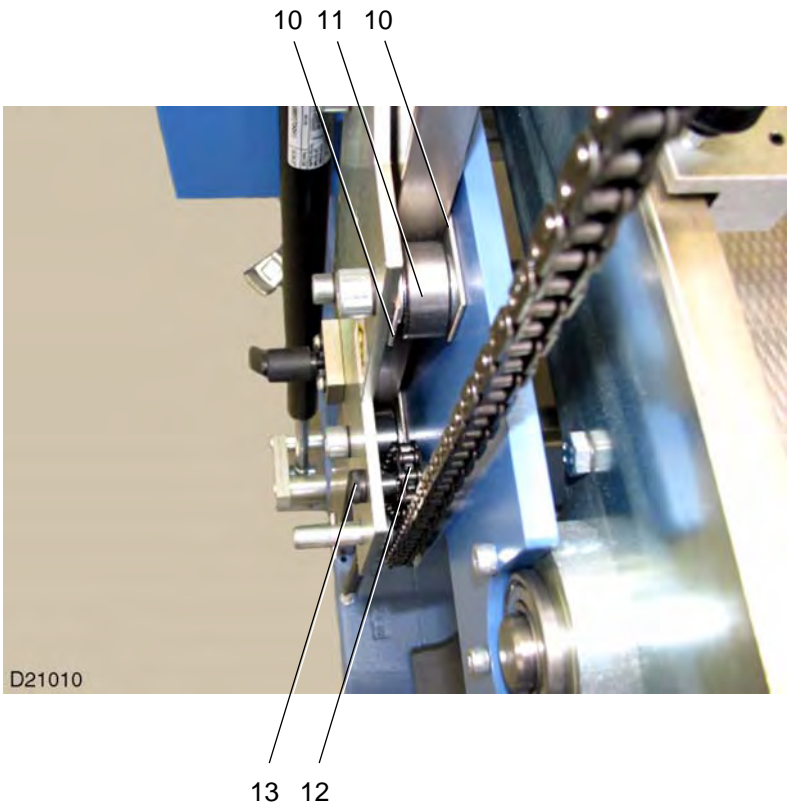

D21010





Schuppenauslage
Stream delivery
Sortie à nappe

ETL_ASP_66/82-2ME
Version: 1.1

7.1

Grundgestell
Basic frame
Châssis de base

Pos.: Nr.: N°:	Bezeichnung	Designation	Désignation	Teile-Nr.: Partial-No.: Numéro partiel:
1	Seitenteil	side plate	pièce latérale	81.7815.00
2	Gasdruckfeder ASP66-2ME ASP82-2ME	pneumatic spring ASP66-2ME ASP82-2ME	ressort pneuamtique ASP66-2ME ASP82-2ME	1308881 1294065
3	Führung	guide	guide	81.7841.03
4	Querträger ASP66-2ME ASP82-2ME	cross bar ASP66-2ME ASP82-2ME	profilé transversal ASP66-2ME ASP82-2ME	81.7815.03 81.7811.00
5	Zylinderschraube	allen screw	vis à tête cylindrique	0089292.5
6	Distanz	distance piece	pièce entretoise	81.7828.007
7	Halteplatte	mounting plate	plaque de montage	81.7844.018
8	Zylinderschraube	allen screw	vis à tête cylindrique	0089227.5
9	Lenkrolle	guide roller	rouleau de guidage	0104506
10	Platte	plate	plaque	4.0.8343.220
11	Laufrolle	idler roller	galet de roulement	0111716
12	Kettenrad Lagerbuchse	sprocket wheel bearing bush	roue à chaîne douille de palier	4.0.8334.030 0110601
13	Passschraube	dowel screw	boulon ajusté	0096215

	Schuppenauslage Stream delivery Sortie à nappe	ETL_ASP_66/82-2ME	7.1	Grundgestell Basic frame Châssis de base	 5
		Version: 1.1			

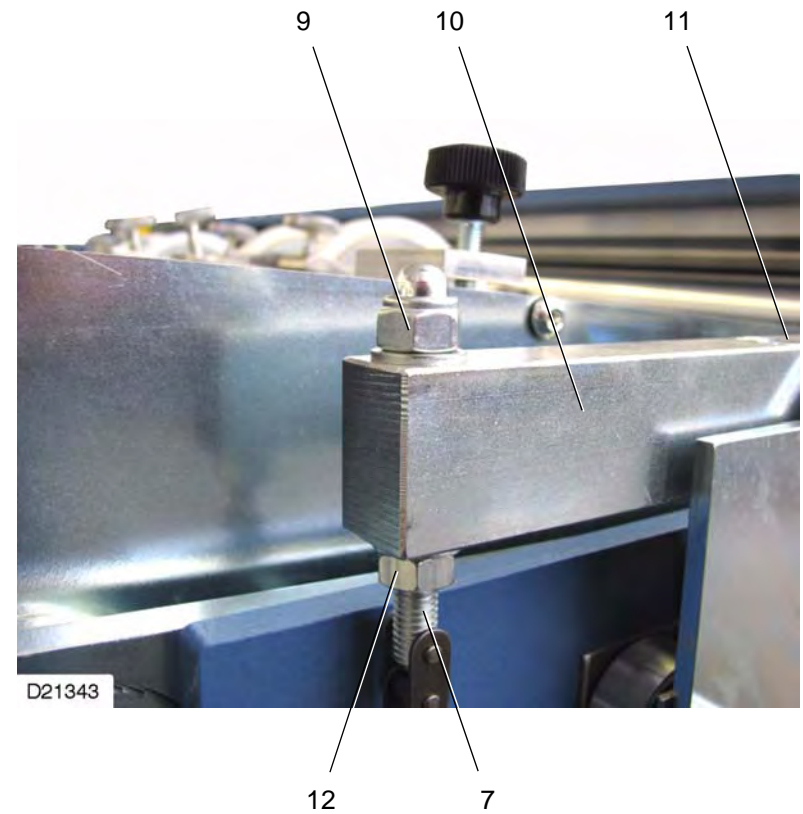
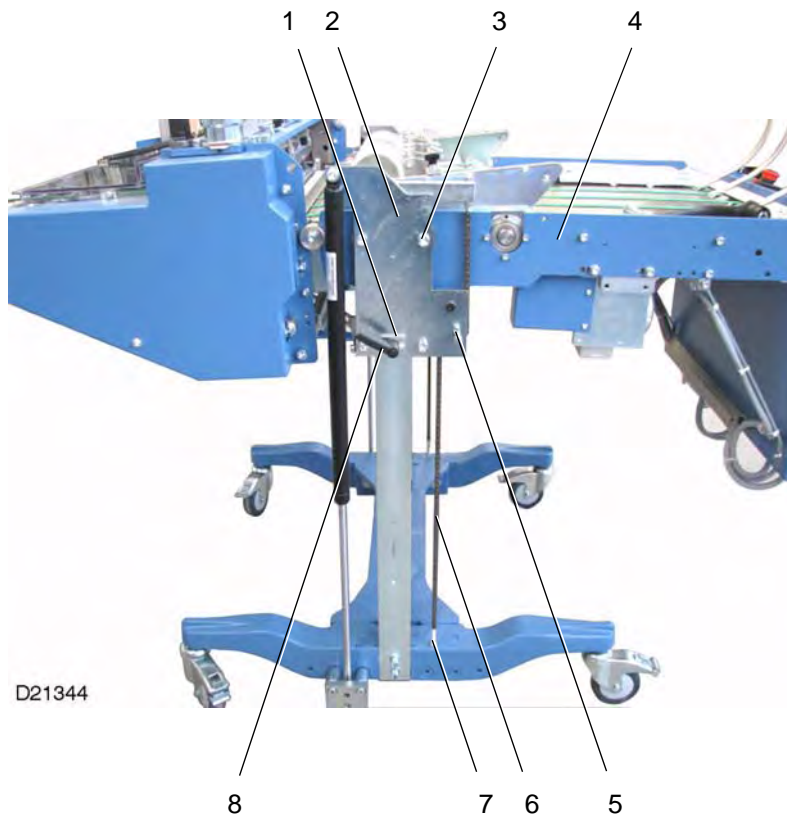

Schuppenauslage
Stream delivery
Sortie à nappe

ETL_ASP_66/82-2ME

Version: 1.1

7.1

Grundgestell
Basic frame
Châssis de base



6

Pos.: Nr.: N°:	Bezeichnung	Designation	Désignation	Teile-Nr.: Partial-No.: Numéro partiel:
1	Halter Zylinderschraube Scheibe	support allen screw washer	support vis à tête cylindrique rondelle	83.8344.88 0088807.5 0086116.5
2	Platte	plate	plaque	81.8564.060
3	Zylinderschraube Scheibe	allen screw washer	vis à tête cylindrique rondelle	0094908.5 0086215.5
4	Seitenteil	side plate	pièce latérale	81.8541.063
5	Welle ASP66-2ME ASP82-2ME Lagerbuchse	shaft ASP66-2ME ASP82-2ME bearing bush	arbre ASP66-2ME ASP82-2ME douille de palier	81.7821.05 81.7821.07 0110635
6	Kette Steckglied Ketten-Doppelglied	chain connector link double chain link	chaîne pièce de raccord maillon	0108796 0109058 0109086
7	Stellschraube Sechskantmutter	adjustment screw hexagon nut	vis de réglage écrou à six pans	4.0.8329.080 0090878.5
8	Klemmhebel	clamping lever	levier de blocage	0100586
9	Hutmutter Scheibe	cap nut washer	écrou borgne rondelle	0093641.5 0086124.5
10	Halter	support	support	81.8544.76
11	Zylinderschraube	allen screw	vis à tête cylindrique	0089201.5
12	Sechskantmutter	hexagon nut	écrou à six pans	0090878.5



D21341

1



Schuppenauslage
Stream delivery
Sortie à nappe

ETL_ASP_66/82-2ME

Version: 1.1



7.1

Grundgestell
Basic frame
Châssis de base



8

Pos.: Nr.: N°:	Bezeichnung	Designation	Désignation	Teile-Nr.: Partial-No.: Numéro partiel:
1	Handkurbel kpl.	crank handle cpl.	manivelle cpl.	81.7800.51

	Schuppenauslage Stream delivery Sortie à nappe	ETL_ASP_66/82-2ME	7.1	Grundgestell Basic frame Châssis de base	 9
		Version: 1.1			

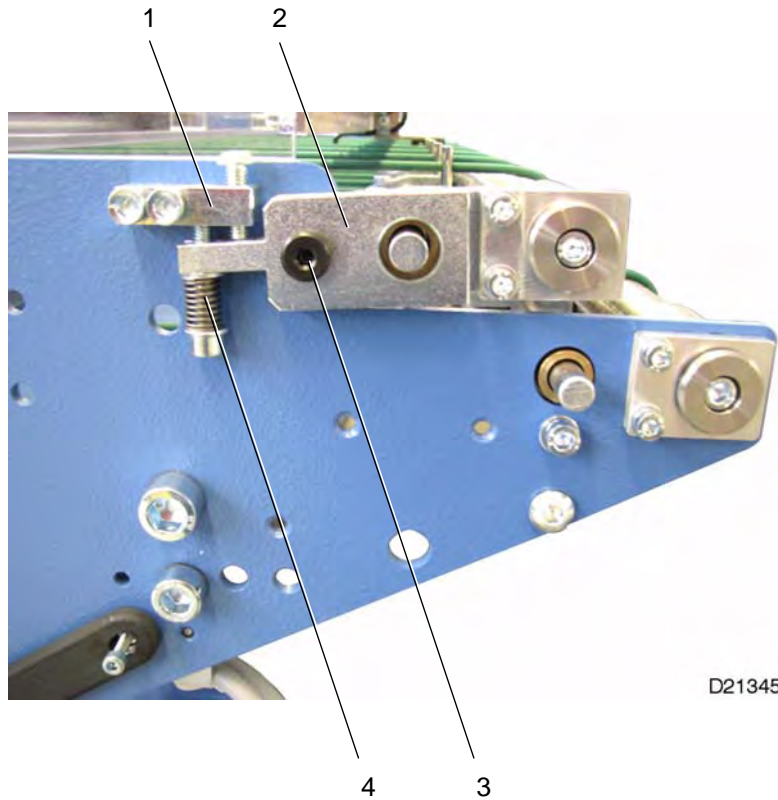

D21345

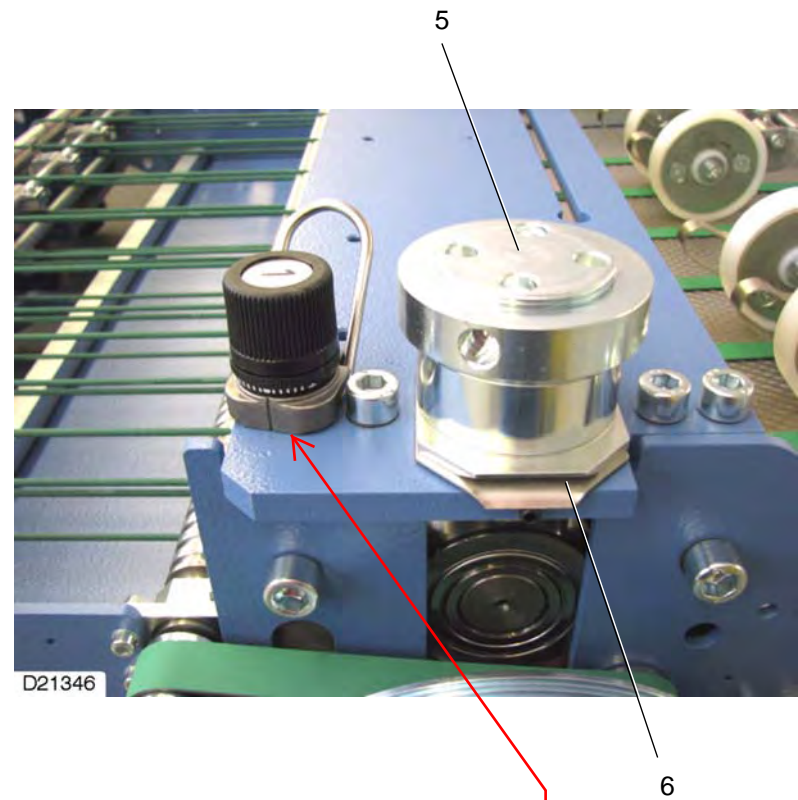

D21346

white plastic bushing 0111138



Schuppenauslage
Stream delivery
Sortie à nappe

ETL_ASP_66/82-2ME

Version: 1.1



7.2

Presswalzenstation
Press roller station
Poste de rouleau de pression



Pos.: Nr.: N°:	Bezeichnung	Designation	Désignation	Teile-Nr.: Partial-No.: Numéro partiel:
1	Leiste	bar	barre	83.8544.129
2	Wippe	pivot lever	bascule	83.8544.128
3	Passschraube	dowel screw	boulon ajusté	0096167
	Scheibe	washer	rondelle	0086116.5
	Sechskantmutter	hexagon nut	écrou à six pans	0086850.5
4	Feder	spring	ressort	0102778
	Zylinderschraube	allen screw	vis à tête cylindrique	0088872.5
	Scheibe	washer	rondelle	0086108.5
5	Verstellung kpl.	adjustment cpl.	réglage cpl.	83.0000.104
	Hakenschlüssel	hook wrench	clé à ergot	0102112
6	Papieranschlag kpl.	sheet stop cpl.	butée papier cpl.	83.0000.43
	Scheibe	washer	rondelle	4.0.8362.010
	Scheibe	washer	rondelle	4.0.8362.030
	Spannstift	spring pin	goupille élastique	0093302

brass bushing #5 screws into 4.0.8329.050

	Schuppenauslage Stream delivery Sortie à nappe	ETL_ASP_66/82-2ME	7.2	Presswalzenstation Press roller station Poste de rouleau de pression	
		Version: 1.1			

brass bushing
4.0.8329.050

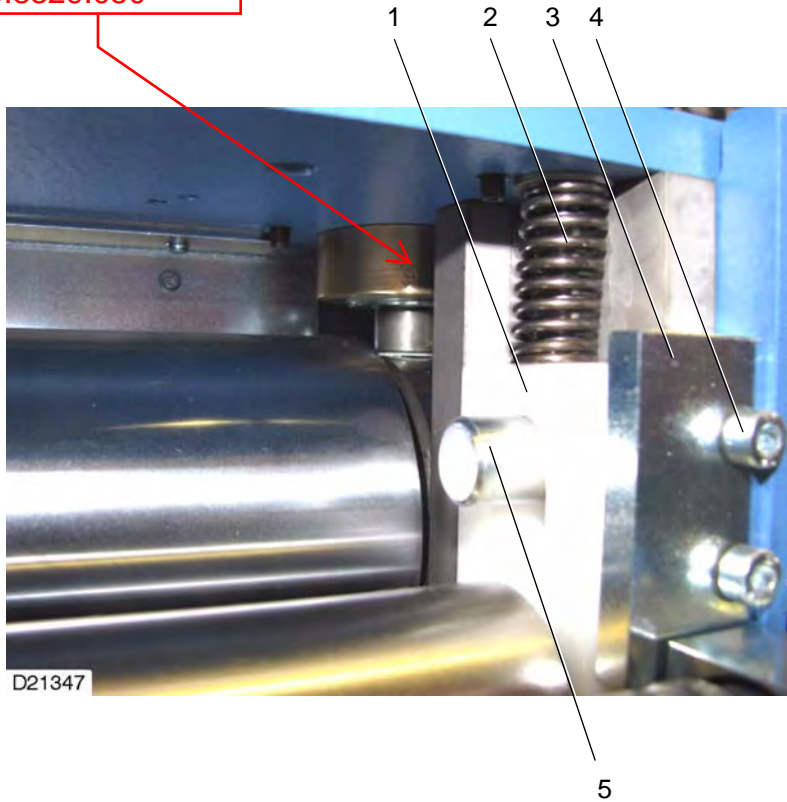

D21347

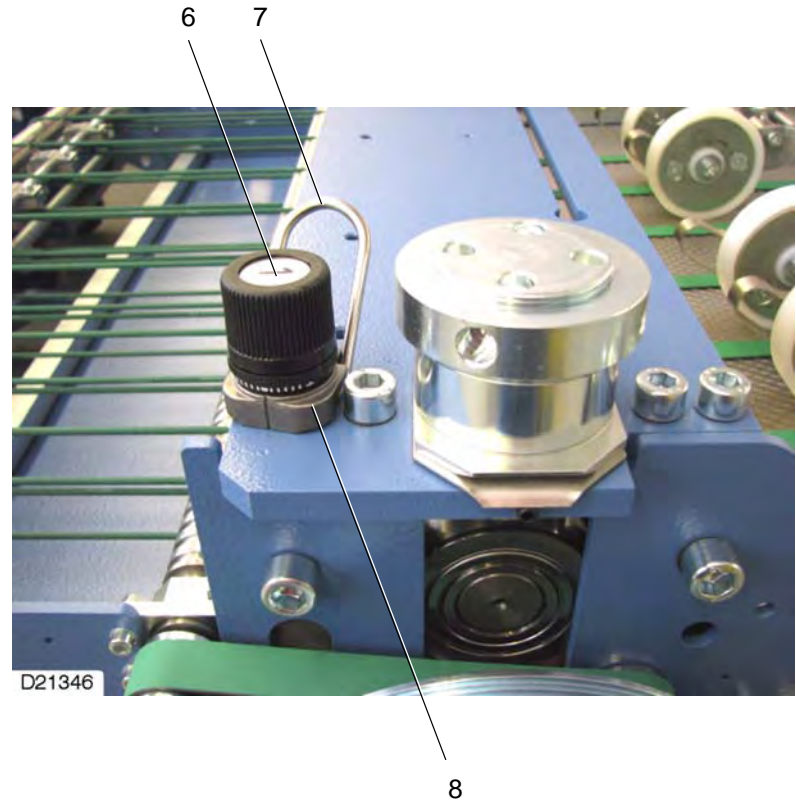

D21346



Schuppenauslage
Stream delivery
Sortie à nappe

ETL_ASP_66/82-2ME

Version: 1.1

7.2

Presswalzenstation
Press roller station
Poste de rouleau de pression



12

Pos.: Nr.: N°:	Bezeichnung	Designation	Désignation	Teile-Nr.: Partial-No.: Numéro partiel:
1	Lagerstück	supporting piece	pièce de support	4.0.8344.120
2	Feder	spring	ressort	0102939
	Feder	spring	ressort	0102772
	Scheibe	washer	rondelle	4.0.8328.080
3	Lasche	connecting link	eclisse	4.0.8344.110
4	Zylinderschraube	allen screw	vis à tête cylindrique	0088666.5
5	Stellmutter	adjusting nut	écrou de réglage	4.0.8329.031
6	Griff kpl.	handle cpl.	poignée cpl.	17.5400.026
	Stellschraube	adjustment screw	vis de réglage	4.0.8329.020
7	Abdrückbügel	bow	fourchette	2.0.5486.010
8	Druckstück	thrust piece	pièce de retenue	4.0.8315.010

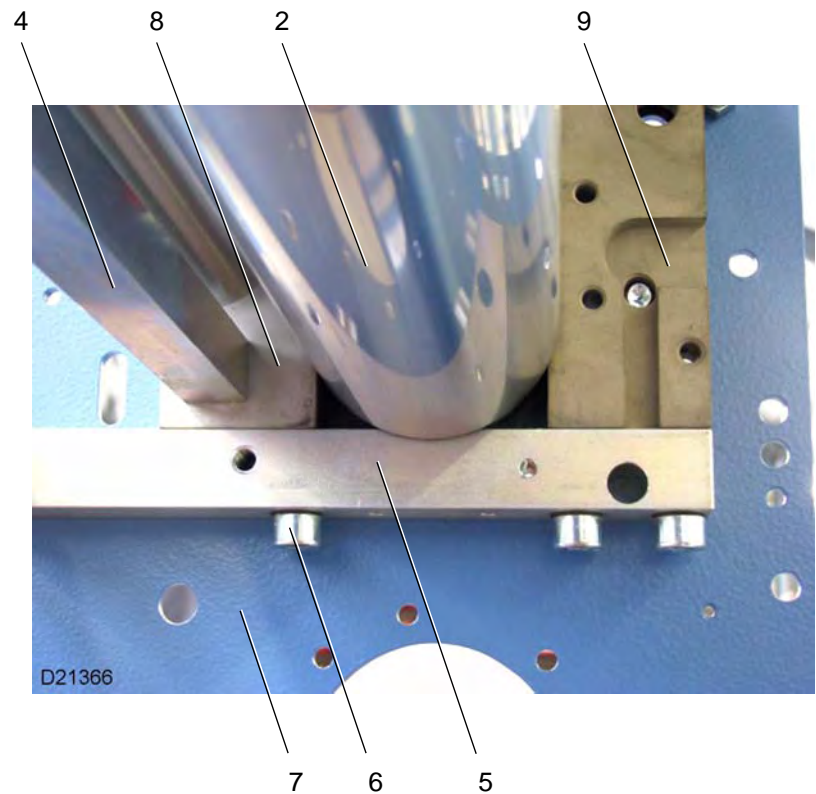
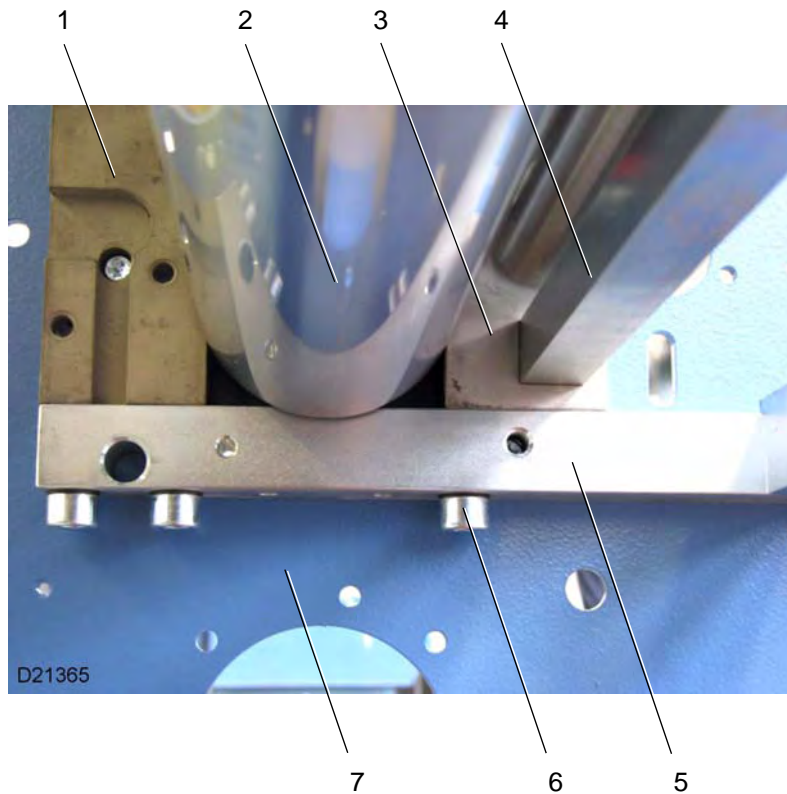

Schuppenauslage
Stream delivery
Sortie à nappe

ETL_ASP_66/82-2ME



Version: 1.1

7.2

Presswalzenstation
Press roller station
Poste de rouleau de pression



Pos.: Nr.: N°:	Bezeichnung	Designation	Désignation	Teile-Nr.: Partial-No.: Numéro partiel:
1	Leiste	bar	barre	4.0.8344.030
2	Presswalze ASP66-2ME ASP82-2ME	press roller ASP66-2ME ASP82-2ME	rouleau de pression ASP66-2ME ASP82-2ME	83.8322.00 83.8322.07
3	Leiste	bar	barre	4.0.8344.020
4	Traverse ASP66-2ME ASP82-2ME	cross bar ASP66-2ME ASP82-2ME	traverse ASP66-2ME ASP82-2ME	83.8341.51 83.8341.52
5	Träger	support	support	4.0.8343.010
6	Zylinderschraube	allen screw	vis à tête cylindrique	0089201.5
7	Seitenteil	side plate	pièce latérale	83.8364.056
8	Leiste	bar	barre	4.0.8344.010
9	Leiste	bar	barre	4.0.8344.040

	Schuppenauslage Stream delivery Sortie à nappe	ETL_ASP_66/82-2ME	7.2	Presswalzenstation Press roller station Poste de rouleau de pression	 15
		Version: 1.1			

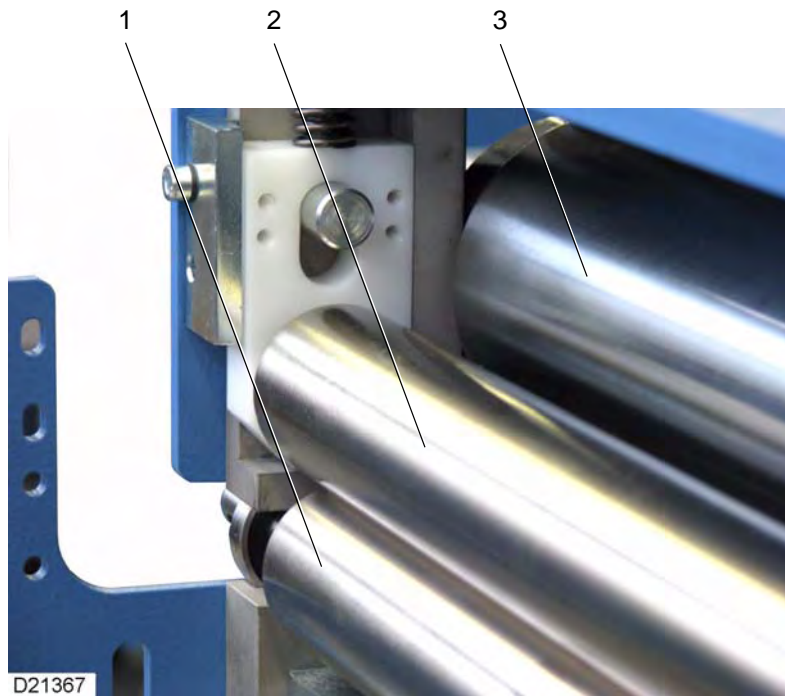

D21367

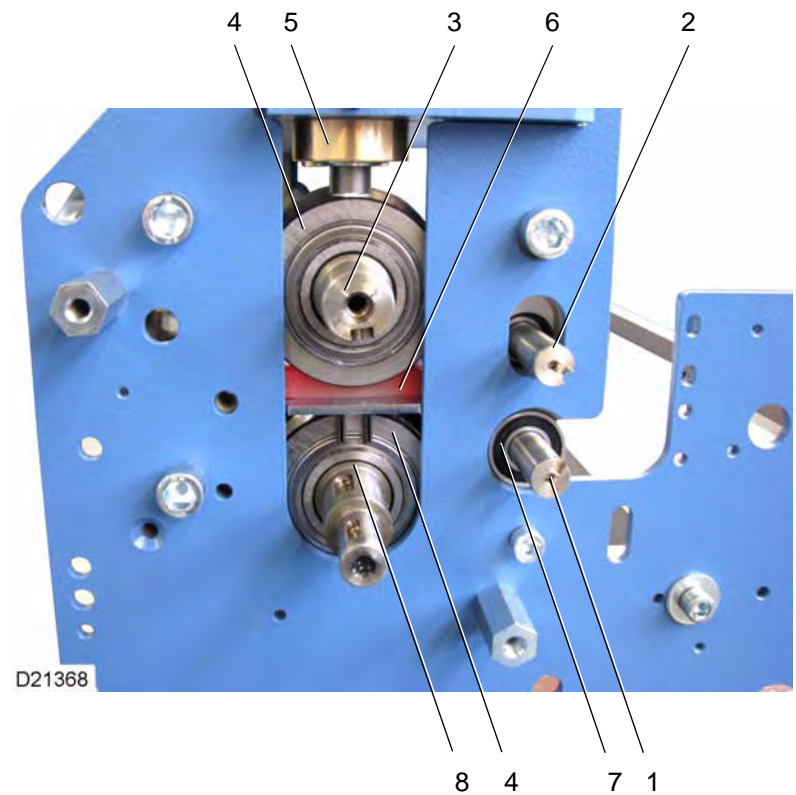

D21368



Schuppenauslage
Stream delivery
Sortie à nappe

ETL_ASP_66/82-2ME

Version: 1.1

7.2

Presswalzenstation
Press roller station
Poste de rouleau de pression



16

Pos.: Nr.: N°:	Bezeichnung	Designation	Désignation	Teile-Nr.: Partial-No.: Numéro partiel:
1	Walze	roller	rouleau	
	ASP66-2ME	ASP66-2ME	ASP66-2ME	83.8322.02
	ASP82-2ME	ASP82-2ME	ASP82-2ME	83.8322.05
	Paßfeder	key	ressort d'austage	0094334
	Tellerfeder	spring washer	rondelle belleville	0103317
2	Walze	roller	rouleau	
	ASP66-2ME	ASP66-2ME	ASP66-2ME	83.8322.01
	ASP82-2ME	ASP82-2ME	ASP82-2ME	83.8322.06
	Paßfeder	key	ressort d'austage	0094334
	Tellerfeder	spring washer	rondelle belleville	0103317
3	Presswalze	press roller	rouleau de pression	
	ASP66-2ME	ASP66-2ME	ASP66-2ME	83.8322.03
	ASP82-2ME	ASP82-2ME	ASP82-2ME	83.8322.04
4	Laufrolle	idler roller	galet de roulement	0111724
5	Verstellung kpl.	adjustment cpl.	réglage cpl.	83.0000.104
6	Federleiste	spring rail	barre à ressorts	83.8344.112
7	Kugellager	ball bearing	roulement à billes	0109678
8	Presswalze	press roller	rouleau de pression	
	ASP66-2ME	ASP66-2ME	ASP66-2ME	83.8322.00
	ASP82-2ME	ASP82-2ME	ASP82-2ME	83.8322.07

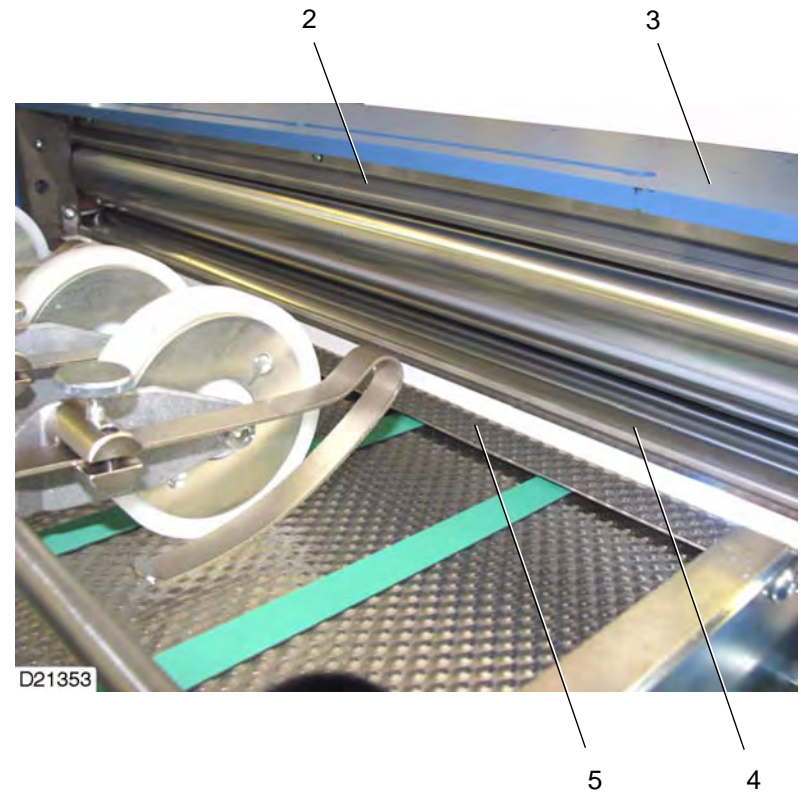
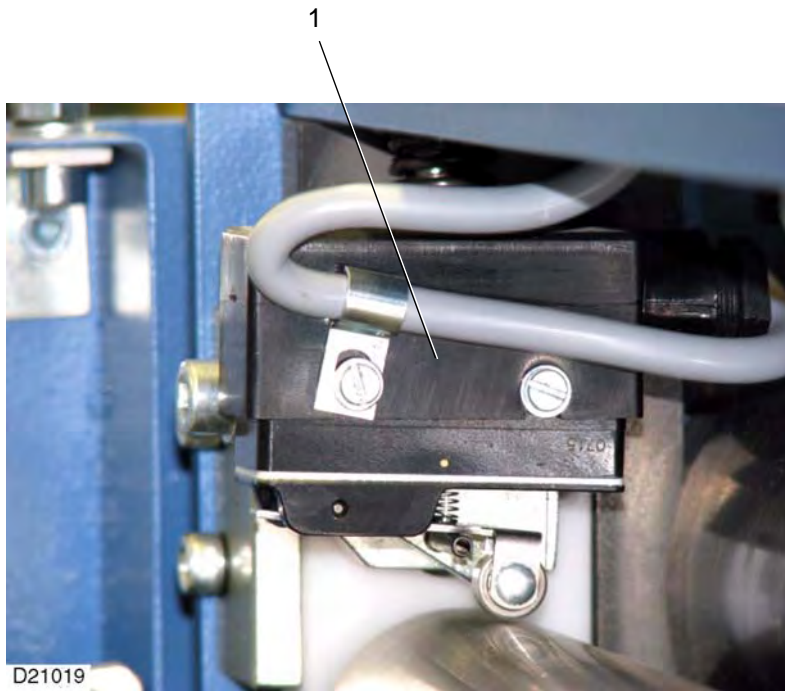

Schuppenauslage
Stream delivery
Sortie à nappe

ETL_ASP_66/82-2ME

Version: 1.1

7.2

Presswalzenstation
Press roller station
Poste de rouleau de pression



18

Pos.: Nr.: N°:	Bezeichnung	Designation	Désignation	Teile-Nr.: Partial-No.: Numéro partiel:
1	Mikroschalter links	microswitch left	microrupteur à gauche	83.0000.44
	Mikroschalter rechts	microswitch right	microrupteur à droite	83.0000.45
2	Abweisblech	finger-guard	tôle de protection	
	ASP66-2ME	ASP66-2ME	ASP66-2ME	83.8361.41
	ASP82-2ME	ASP82-2ME	ASP82-2ME	83.8361.42
	Linsenschraube	fillister head screw	vis à tête bombée	0095931.5
3	Scheibe	washer	rondelle	0086108.5
	Platte	plate	plaque	
	ASP66-2ME	ASP66-2ME	ASP66-2ME	83.8341.35
	ASP82-2ME	ASP82-2ME	ASP82-2ME	83.8341.54
	Zylinderschraube	allen screw	vis à tête cylindrique	0089185.5
	Sicherungsscheibe	safety washer	rondelle de blocage	0101568
4	Verschlusschraube	screw plug	bouchon fileté	0088518.5
	Auslaufschutz	outlet protection	protection de décharge	
	ASP66-2ME	ASP66-2ME	ASP66-2ME	81.8562.070
5	ASP82-2ME	ASP82-2ME	ASP82-2ME	81.8562.071
	Auslaufschutz	outlet protection	protection de décharge	
	ASP66-2ME	ASP66-2ME	ASP66-2ME	81.8562.068
	ASP82-2ME	ASP82-2ME	ASP82-2ME	81.8562.069
	Distanzhülse	distance sleeve	douille entretoise	81.8528.044

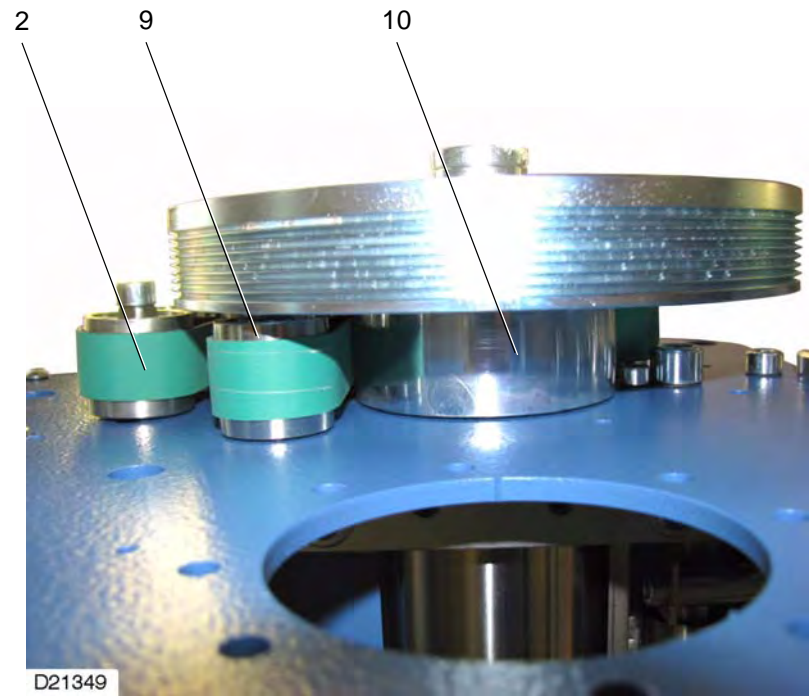
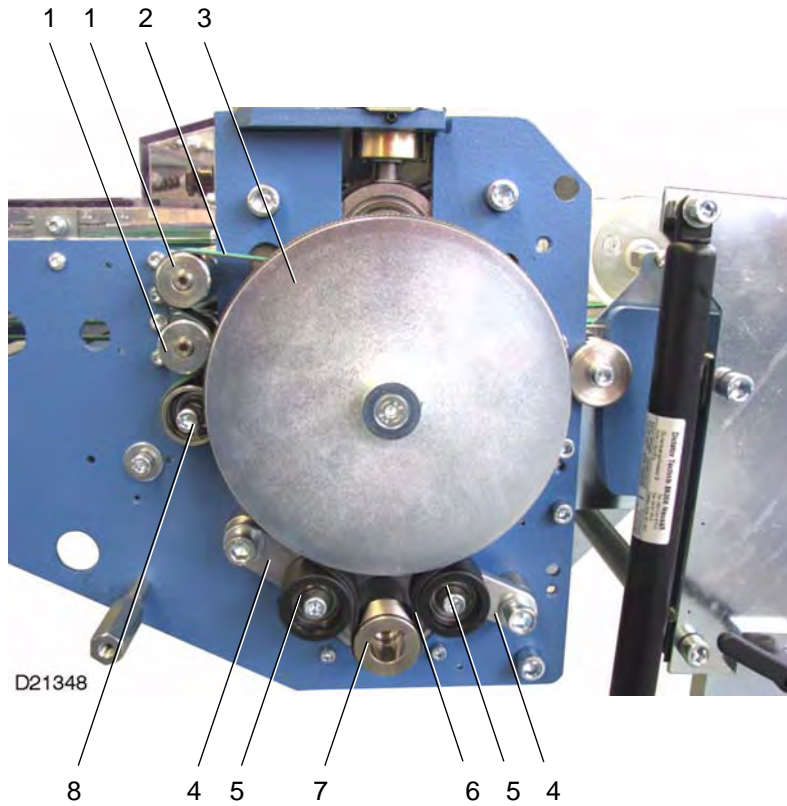

Schuppenauslage
Stream delivery
Sortie à nappe

ETL_ASP_66/82-2ME

Version: 1.1

7.2

Presswalzenstation
Press roller station
Poste de rouleau de pression



20

Pos.: Nr.: N°:	Bezeichnung	Designation	Désignation	Teile-Nr.: Partial-No.: Numéro partiel:
1	Riemenscheibe Gewindestift	pulley grub screw	poulie goupille filetée	83.8332.21 0089862
2	Band	tape	bande	0105271
3	Riemenscheibe Passscheibe Distanzhülse	pulley shim ring distance sleeve	poulie rondelle d'ajustage douille entretoise	83.8333.05 0092510 60 290 150
4	Riemenspanner kpl. Lasche Distanzbuchse Zylinderschraube Scheibe Sechskantmutter	belt tightener cpl. connecting link spacer sleeve allen screw washer hexagon nut	tendeur de courroie cpl. eclisse douille entretoise vis à tête cylindrique rondelle ecrou à six pans	83.8300.79 83.8344.122 83.8328.23 0089326.5 0086215.5 0090910.5
5	Bandrolle Zylinderschraube	tape roller allen screw	galet de transport vis à tête cylindrique	83.8303.00 0089037.5
6	Poly-V-Riemen	V-belt	courroie Poly-V	0107821
7	Riemenscheibe Gewindestift Paßfeder	pulley grub screw key	poulie goupille filetée ressort d'ajustage	83.8333.04 0089582 0094482
8	Bandrolle kpl. Bandrolle Lagerhülse Kugellager Sicherungsring Sicherungsring Passscheibe	tape roller cpl. tape roller bearing bushing ball bearing circlip circlip shim ring	galet de transport cpl. galet de transport coussinet de palier roulement à billes circlip circlip rondelle d'ajustage	5.0.7300.210 5.0.7332.010 70 320 140 0109645 0087429 0087197 0092270
9	Bandrolle kpl. Laufrolle Bandspannrollenlager	tape roller cpl. idler roller roller bearing	galet de transport cpl. galet de roulement roulement à rouleaux	35.7300.09 4.0.6932.030 0111799
10	Riemenscheibe	pulley	poulie	83.8332.20

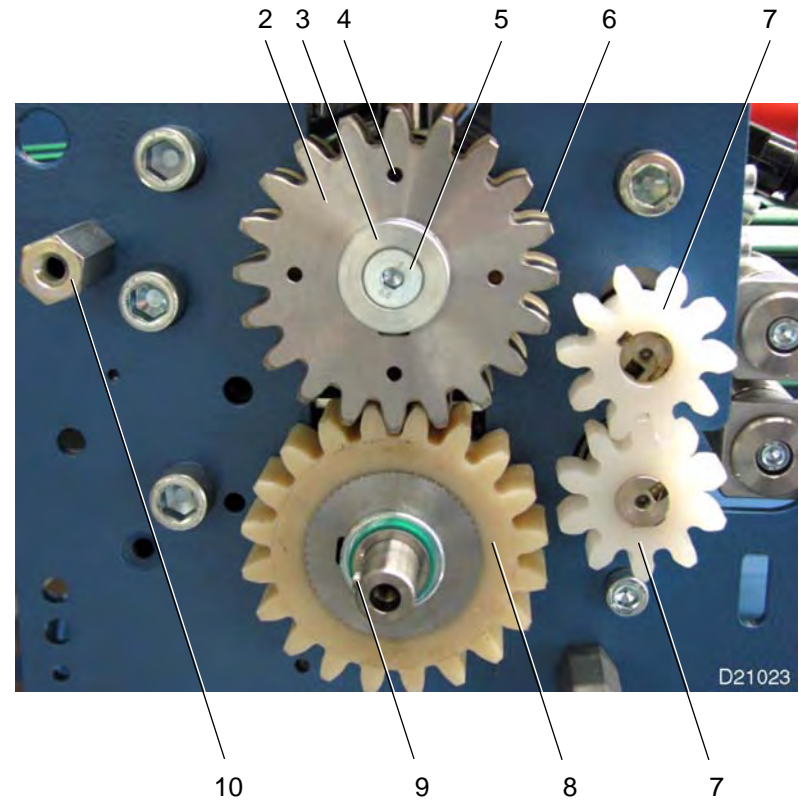
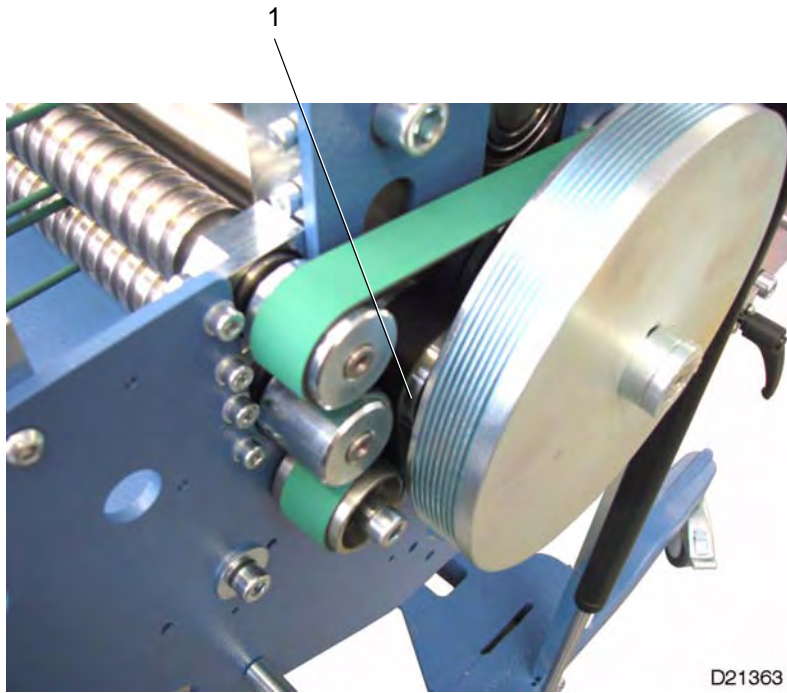

Schuppenauslage
Stream delivery
Sortie à nappe

ETL_ASP_66/82-2ME

Version: 1.1

7.2

Presswalzenstation
Press roller station
Poste de rouleau de pression



22

Pos.: Nr.: N°:	Bezeichnung	Designation	Désignation	Teile-Nr.: Partial-No.: Numéro partiel:
1	Riemenscheibe Gewindestift	pulley grub screw	poulie goupille filetée	83.8332.22 0089862
2	Zahnrad	gear	roue dentée	83.8334.03
3	Scheibe	washer	rondelle	4.0.8328.050
4	Feder	spring	ressort	83.8344.117
5	Senkschraube	countersunk screw	vis à tête fraisée	0095505.5
6	Zahnrad	gear	roue dentée	83.8334.04
7	Zahnrad Paßfeder Gewindestift	gear key grub screw	roue dentée ressort d'ajustage goupille filetée	4.0.8334.020 0094334 0089607
8	Zahnrad	gear	roue dentée	83.8334.05
9	Paßfeder	key	ressort d'ajustage	0094334
10	Stellmutter	adjusting nut	ecrou de réglage	81.8329.01

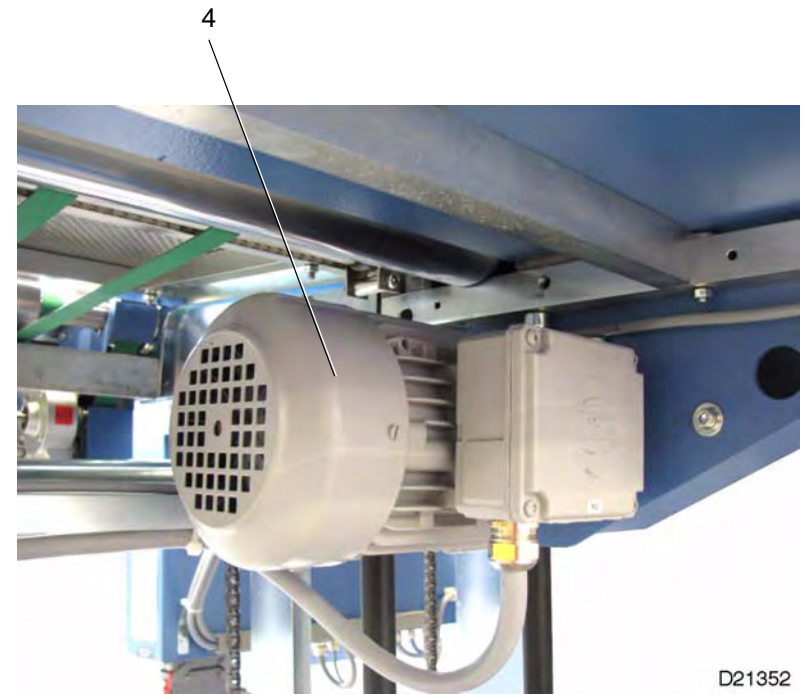
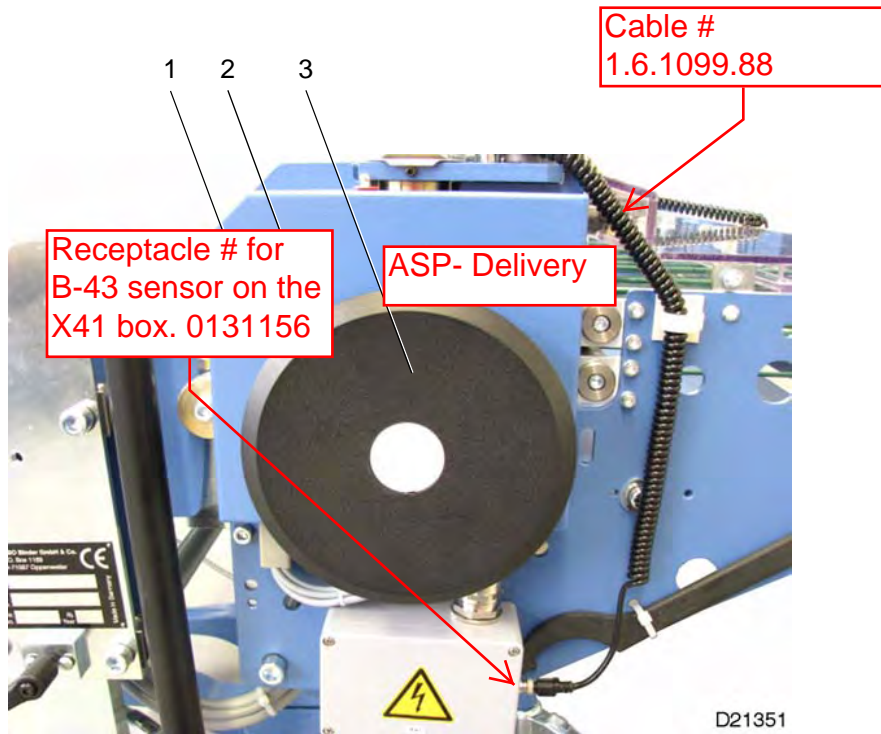

Schuppenauslage
Stream delivery
Sortie à nappe

ETL_ASP_66/82-2ME



Version: 1.1

7.2

Presswalzenstation
Press roller station
Poste de rouleau de pression



Pos.: Nr.: N°:	Bezeichnung	Designation	Désignation	Teile-Nr.: Partial-No.: Numéro partiel:
1	Linsenschraube	fillister head screw	vis à tête bombée	0096024.5
2	Schutzblech	guard plate	tôle de protection	81.8562.47
3	Sicherheitshandrad	safety handwheel	volant à main	1437839
4	Motor	motor	moteur	0103842
	Zylinderschraube	allen screw	vis à tête cylindrique	0088807.5
	Scheibe	washer	rondelle	0086116.5
	Sechskantmutter	hexagon nut	ecrou à six pans	0090852.5

	Schuppenauslage Stream delivery Sortie à nappe	ETL_ASP_66/82-2ME	7.2	Presswalzenstation Press roller station Poste de rouleau de pression	
		Version: 1.1			

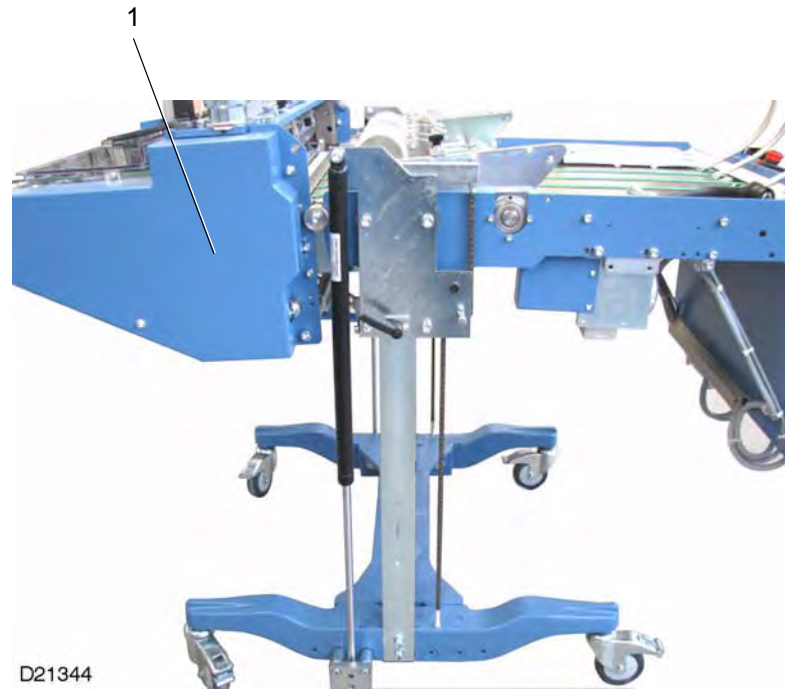

D21344



Schuppenauslage
Stream delivery
Sortie à nappe

ETL_ASP_66/82-2ME

Version: 1.1



7.2

Presswalzenstation
Press roller station
Poste de rouleau de pression



26

Pos.: Nr.: N°:	Bezeichnung	Designation	Désignation	Teile-Nr.: Partial-No.: Numéro partiel:
1	Schutzhaube	guard hood	capot de protection	83.8561.27

	Schuppenauslage Stream delivery Sortie à nappe	ETL_ASP_66/82-2ME	7.2	Presswalzenstation Press roller station Poste de rouleau de pression	 27
		Version: 1.1			

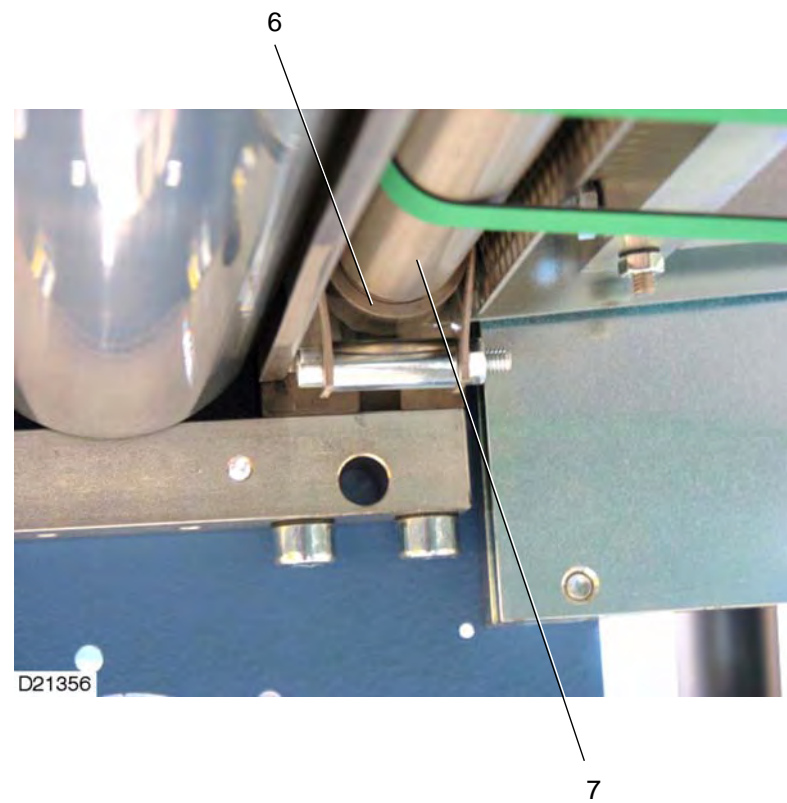
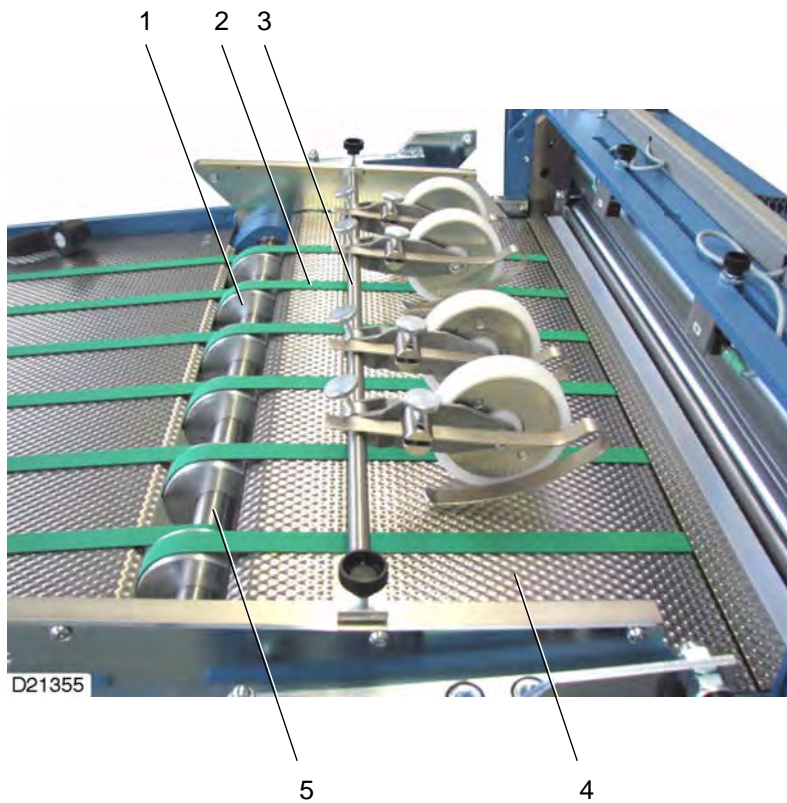

Schuppenauslage
Stream delivery
Sortie à nappe

ETL_ASP_66/82-2ME

Version: 1.1

7.3

Aufschuppband
Shingle tape
Bande à positionner en nappe



28

Pos.: Nr.: N°:	Bezeichnung	Designation	Désignation	Teile-Nr.: Partial-No.: Numéro partiel:
1	Riemenscheibe Gewindestift	pulley grub screw	poulie goupille filetée	81.8532.11 0089706
2	Band	tape	bande	0105351
3	Stange ASP66-2ME ASP82-2ME	rod ASP66-2ME ASP82-2ME	barre ASP66-2ME ASP82-2ME	81.8521.95 81.8521.109
4	Leitblech ASP66-2ME ASP82-2ME	guide plate ASP66-2ME ASP82-2ME	tôle de guidage ASP66-2ME ASP82-2ME	81.8561.40 81.8561.53
5	Welle ASP66-2ME ASP82-2ME	shaft ASP66-2ME ASP82-2ME	arbre ASP66-2ME ASP82-2ME	81.8521.93 81.8521.108
6	Lagerflansch Kugellager Sechskantschraube Scheibe	bearing flange ball bearing hexagon-head screw washer	flasque de support roulement à billes vis à six pans rondelle	81.8527.12 0109645 0090457.5 0086124.5
7	Welle ASP66-2ME ASP82-2ME	shaft ASP66-2ME ASP82-2ME	arbre ASP66-2ME ASP82-2ME	81.8521.104 81.8521.107

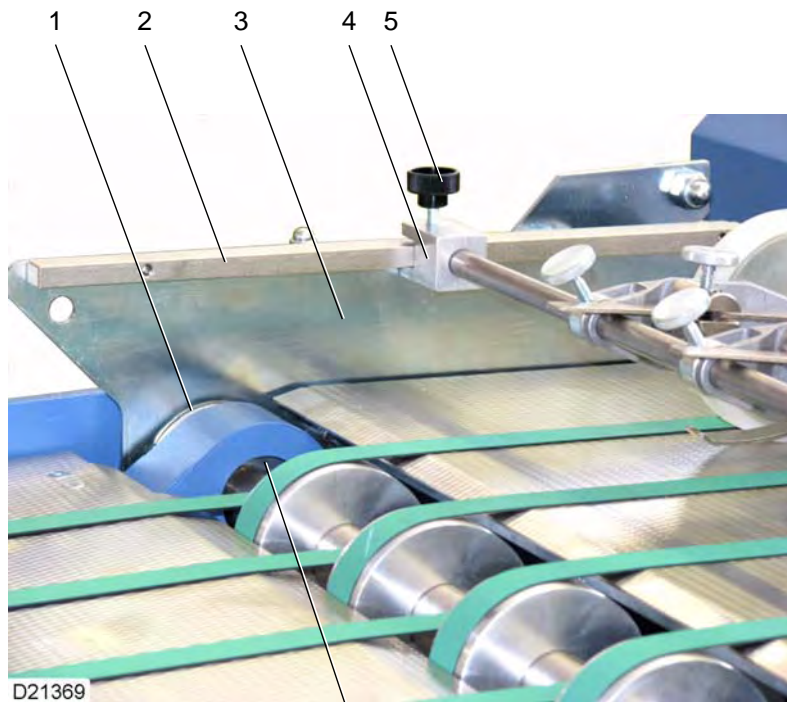

D21369

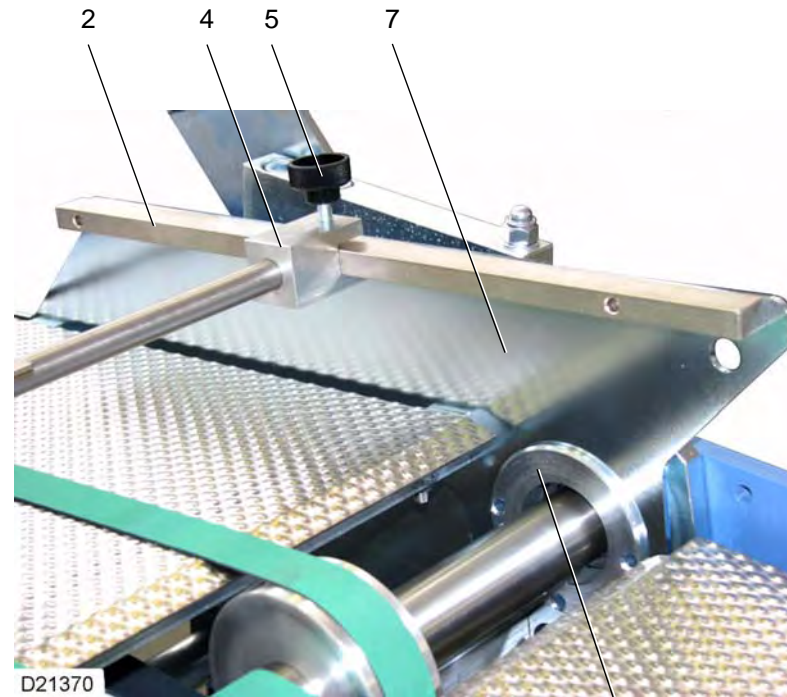

D21370



Schuppenauslage
Stream delivery
Sortie à nappe

ETL_ASP_66/82-2ME

Version: 1.1

7.3

Aufschuppband
Shingle tape
Bande à positionner en nappe



Pos.: Nr.: N°:	Bezeichnung	Designation	Désignation	Teile-Nr.: Partial-No.: Numéro partiel:
1	Lagerflansch Kugellager Distanzbuchse Zylinderschraube Scheibe	bearing flange ball bearing spacer sleeve allen screw washer	flasque de support roulement à billes douille entretoise vis à tête cylindrique rondelle	81.8527.13 0109827 81.8328.07 0088823.5 0086116.5
2	Schiene Zylinderschraube	rail allen screw	barre de support vis à tête cylindrique	81.8544.69 0088799.5
3	Seitenteil	side plate	pièce latérale	81.8561.31
4	Halter	support	support	81.8544.68
5	Rändelhohlschraube	knurled screw	vis moletée	0095828
6	Bandrolle Gewindestift	tape roller grub screw	galet de transport goupille filetée	83.8532.05 0089698
7	Seitenteil	side plate	pièce latérale	81.8561.32

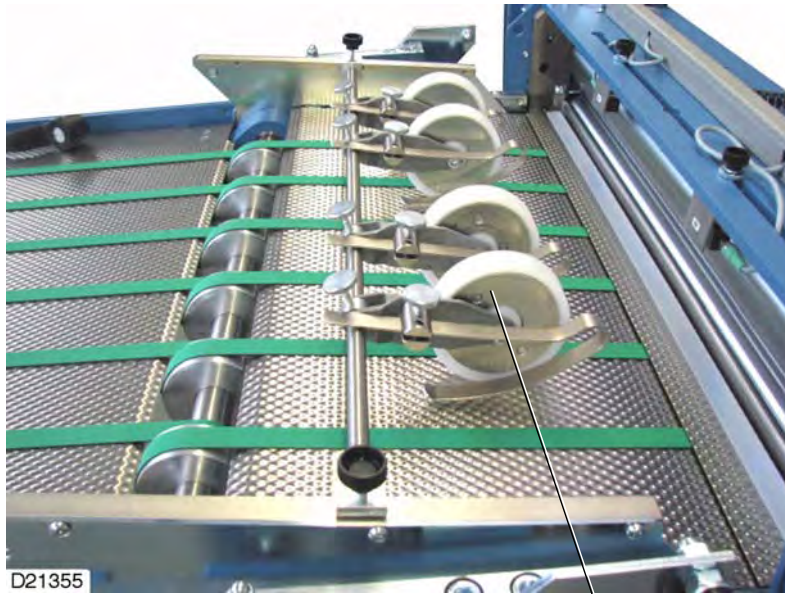

1

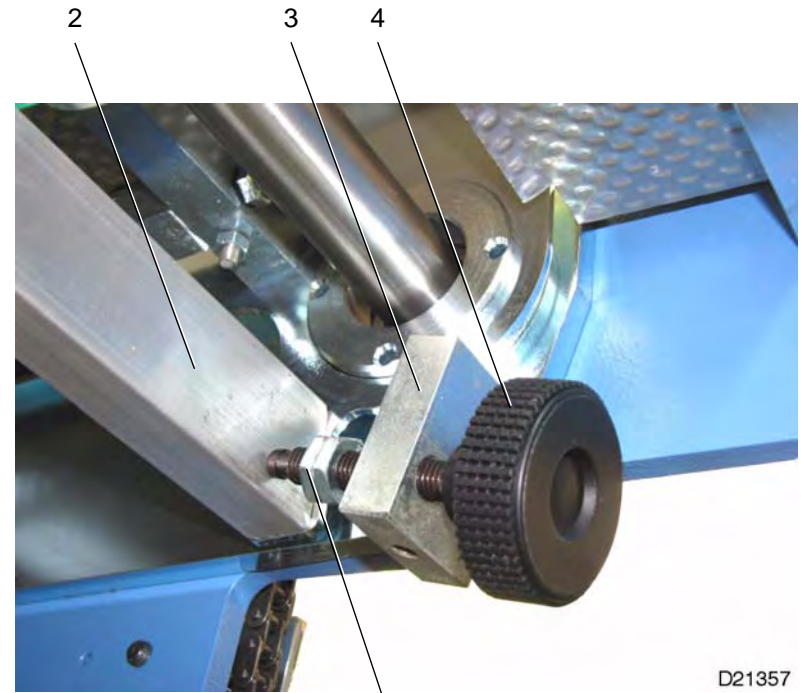

2

3

4

5

D21357



Schuppenauslage
Stream delivery
Sortie à nappe

ETL_ASP_66/82-2ME

Version: 1.1

7.3

Aufschuppband
Shingle tape
Bande à positionner en nappe



Pos.: Nr.: N°:	Bezeichnung	Designation	Désignation	Teile-Nr.: Partial-No.: Numéro partiel:
1	Rollenhebel kpl. Rad Bolzen Bolzen Scheibe Scheibe Hebel Gleitbügel Rändelschraube	roller lever cpl. wheel pin pin washer washer lever slide strip knurled screw	levier à galet cpl. roue axe axe rondelle rondelle levier cordon de transport vis moletée	81.8500.10 81.8503.00 81.8525.00 81.8525.01 81.8526.01 81.8526.02 81.8562.00 81.8562.01 0087908.5
2	Traverse ASP66-2ME ASP82-2ME Senkschraube	cross bar ASP66-2ME ASP82-2ME countersunk screw	traverse ASP66-2ME ASP82-2ME vis à tête fraisée	81.8541.47 81.8541.57 0095493.5
3	Gegenlager Senkschraube	counter bearing countersunk screw	palier-support vis à tête fraisée	81.8544.61 0095406.5
4	Kordelgriff	knurled grip	poignée moletée	0100270
5	Sechskantmutter	hexagon nut	ecrou à six pans	0086884.5

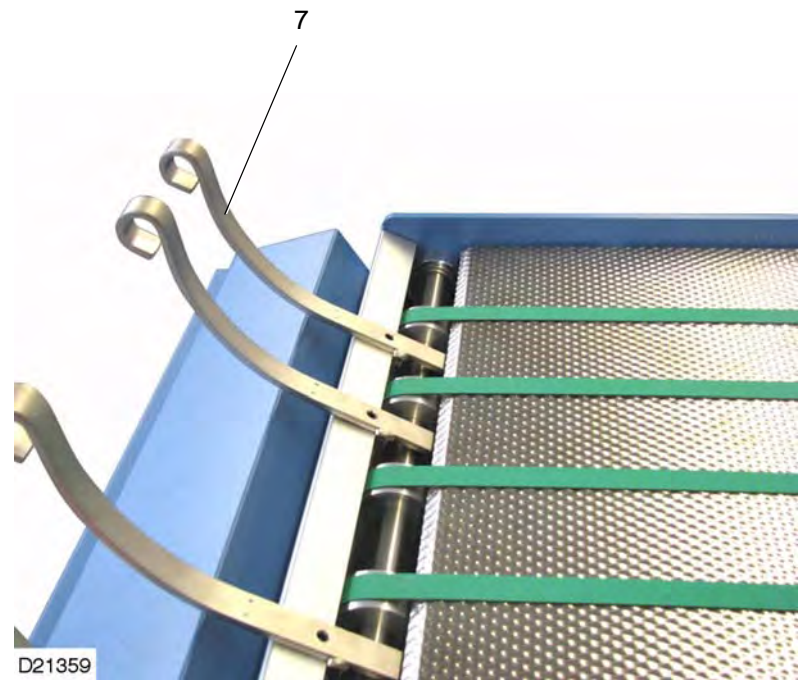
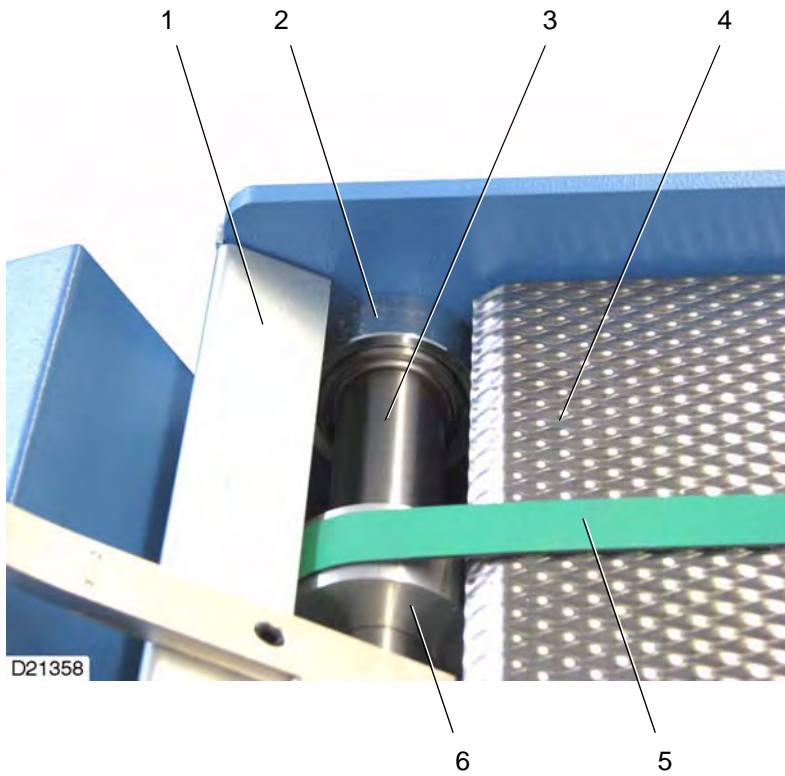

Pos.: Nr.: N°:	Bezeichnung	Designation	Désignation	Teile-Nr.: Partial-No.: Numéro partiel:
1	Abschlußblech ASP66-2ME ASP82-2ME Linsenschraube Scheibe	closing panel ASP66-2ME ASP82-2ME fillister head screw washer	plaque de recouvrement ASP66-2ME ASP82-2ME vis à tête bombée rondelle	81.8561.43 81.8561.55 0096008.5 0086116.5
2	Lagerschale Kugellager Zylinderschraube Scheibe	bearing shell ball bearing allen screw washer	palier roulement à billes vis à tête cylindrique rondelle	30 320 010 0109728 0089268.5 0086215.5
3	Welle ASP66-2ME ASP82-2ME	shaft ASP66-2ME ASP82-2ME	arbre ASP66-2ME ASP82-2ME	81.8521.86 81.8521.110
4	Leitblech ASP66-2ME ASP82-2ME	guide plate ASP66-2ME ASP82-2ME	tôle de guidage ASP66-2ME ASP82-2ME	81.8561.41 81.8561.54
5	Band	tape	bande	0105433
6	Bandrolle Gewindestift	tape roller grub screw	galet de transport goupille fileté	83.8532.05 0089698
7	Leitstab kpl.	guide rail	rail de guidage	81.8500.138

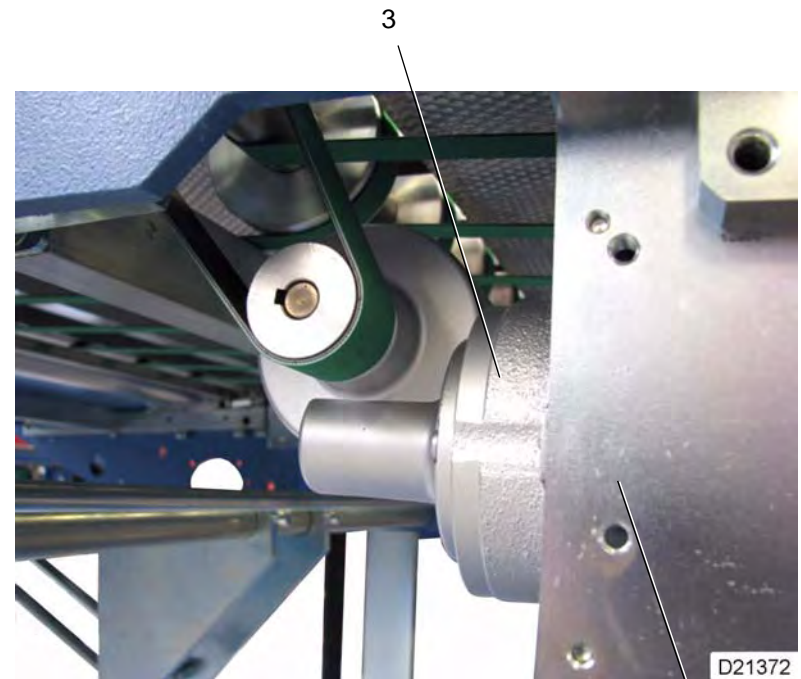
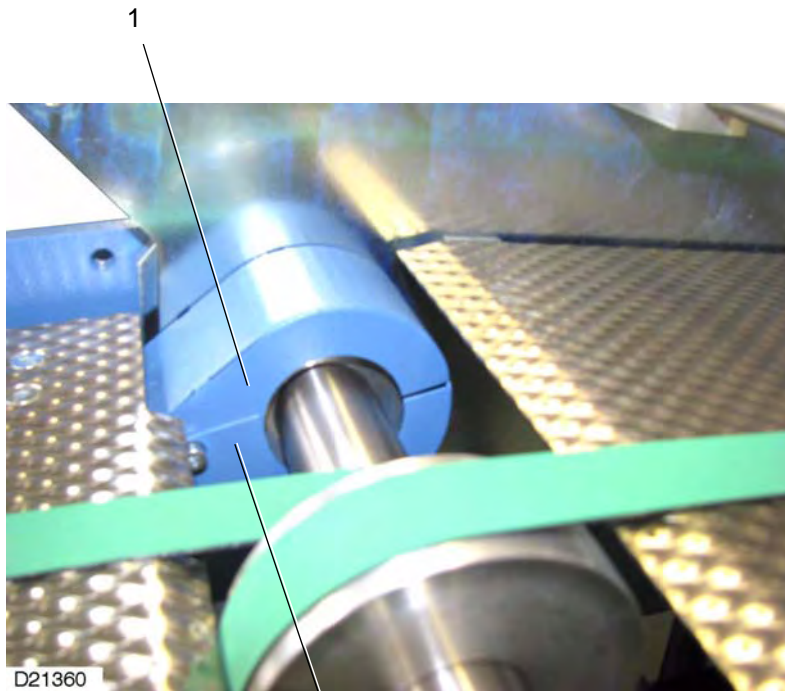

Schuppenauslage
Stream delivery
Sortie à nappe

ETL_ASP_66/82-2ME

Version: 1.1

7.4

**Auslauf
Outlet
Sortie**



36

Pos.: Nr.: N°:	Bezeichnung	Designation	Désignation	Teile-Nr.: Partial-No.: Numéro partiel:
1	Antriebsschutz	drive guard	protection d'entraînement	81.8562.52
2	Abdeckung	cover	recouvrement	81.8562.055
3	Motor	motor	moteur	0104067
	Zylinderschraube	allen screw	vis à tête cylindrique	0089045.5
	Scheibe	washer	rondelle	0086124.5
4	Motorplatte	motor support	support du moteur	81.8544.65
	Zylinderschraube	allen screw	vis à tête cylindrique	0088823.5

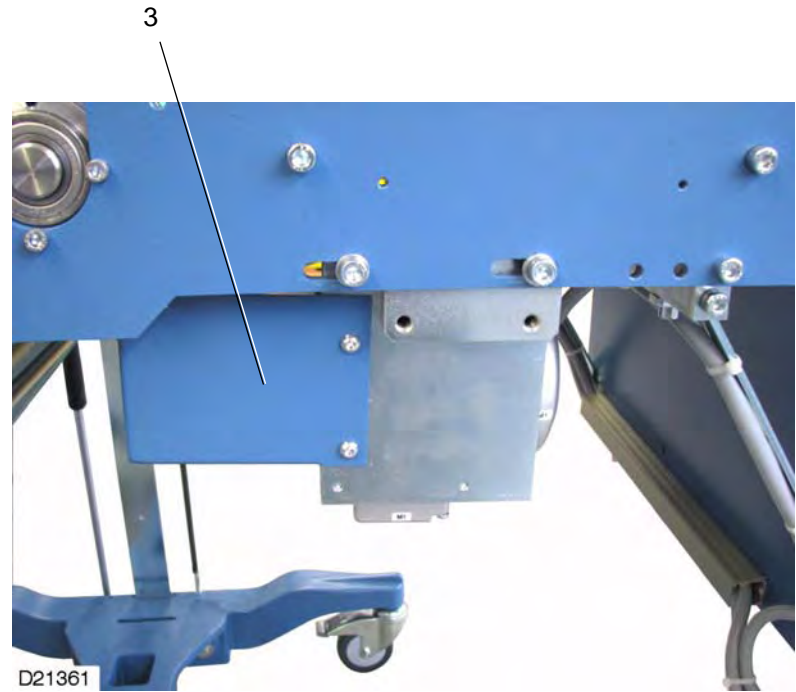
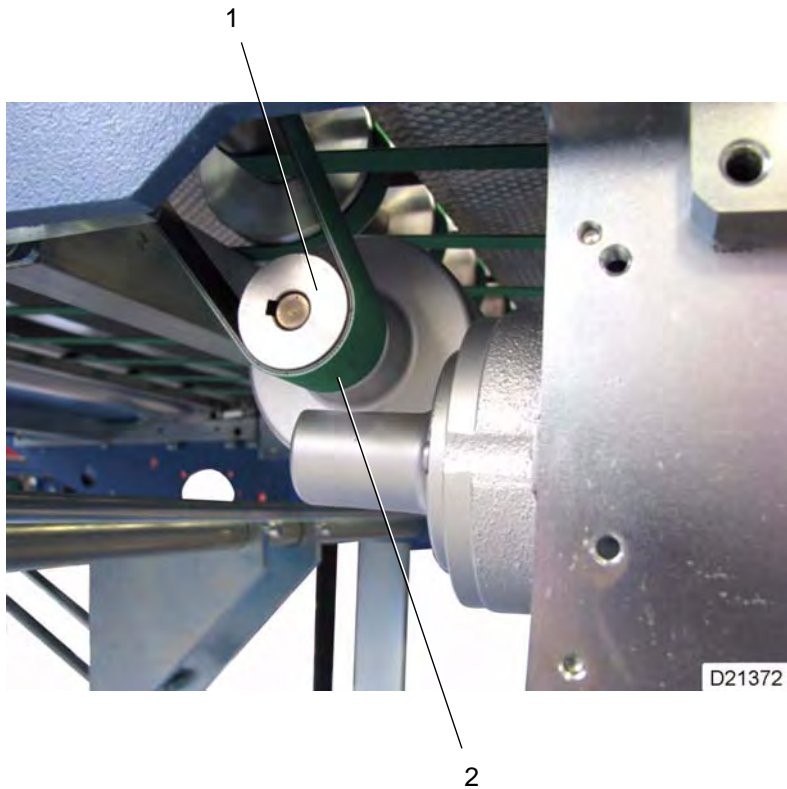

Schuppenauslage
Stream delivery
Sortie à nappe

ETL_ASP_66/82-2ME

Version: 1.1

7.4

**Auslauf
Outlet
Sortie**



38

Pos.: Nr.: N°:	Bezeichnung	Designation	Désignation	Teile-Nr.: Partial-No.: Numéro partiel:
1	Riemenscheibe Gewindestift	pulley grub screw	poulie goupille fileté	81.8532.13 0089607
2	Band	tape	bande	0106208
3	Schutzblech Linsenschraube Scheibe	guard plate fillister head screw washer	tôle de protection vis à tête bombée rondelle	81.8562.42 0095976.5 0086116.5

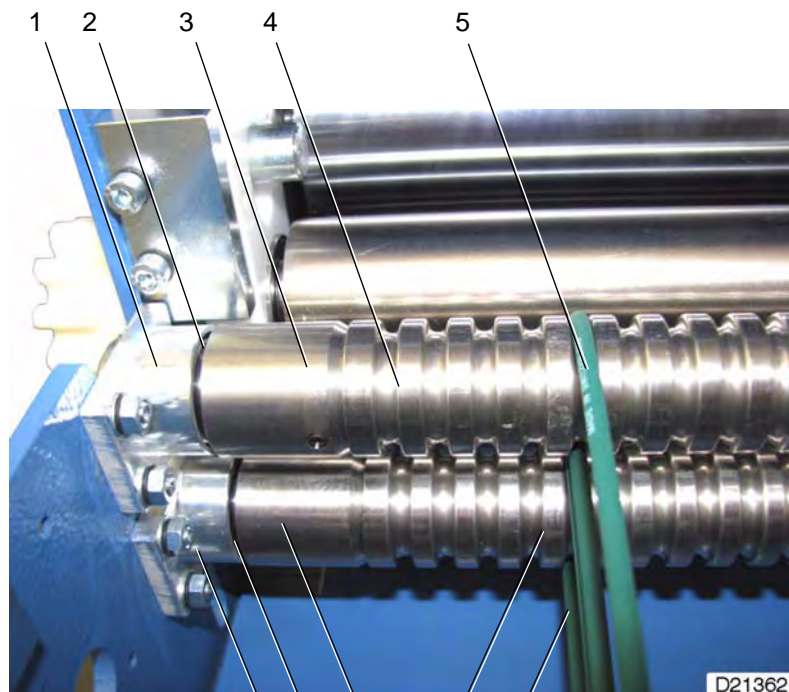

D21362

1 2 3 4 6

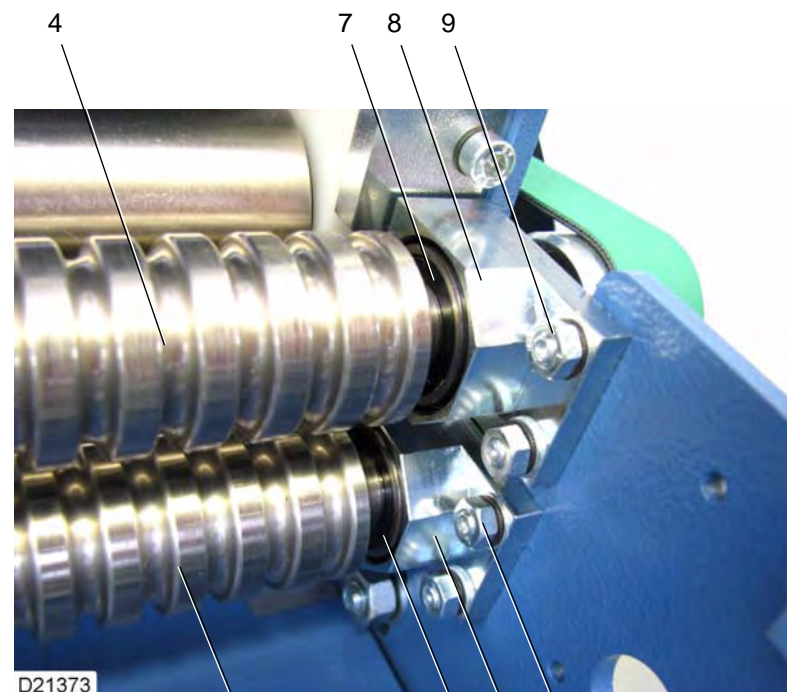

D21373

4 7 8 9



Schuppenauslage
Stream delivery
Sortie à nappe

ETL_ASP_66/82-2ME

Version: 1.1

7.5

Markiereinrichtung
Marking device
Compteur-décaleur



Pos.: Nr.: N°:	Bezeichnung	Designation	Désignation	Teile-Nr.: Partial-No.: Numéro partiel:
1	Lagerflansch Zylinderschraube Scheibe Sechskantmutter Bolzen	bearing flange allen screw washer hexagon nut pin	flasque de support vis à tête cylindrique rondelle ecrou à six pans axe	36.8544.20 0088674.5 0086108.5 0090845.5 83.8525.26
2	Kugellager	ball bearing	roulement à billes	0109611
3	Lagerbuchse Spannstift	bearing bush spring pin	douille de palier goupille élastique	83.8526.25 0094941
4	Welle kpl. ASP66-2ME ASP82-2ME	shaft cpl. ASP66-2ME ASP82-2ME	arbre cpl. ASP66-2ME ASP82-2ME	83.8500.105 83.8500.106
5	Rundriemen	round belt	courroie ronde	0107124
6	Rundriemen	round belt	courroie ronde	0107120
7	Kugellager	ball bearing	roulement à billes	0109610
8	Lagerflansch kpl. Lagerflansch Distanz O-Ring	bearing flange cpl. bearing flange distance piece O-seal	flasque de support cpl. flasque de support pièce entretoise joint torique	36.8500.052 36.8544.034 36.8528.003 0574194
9	Zylinderschraube Scheibe Sechskantmutter	allen screw washer hexagon nut	vis à tête cylindrique rondelle ecrou à six pans	0088674.5 0086108.5 0090845.5

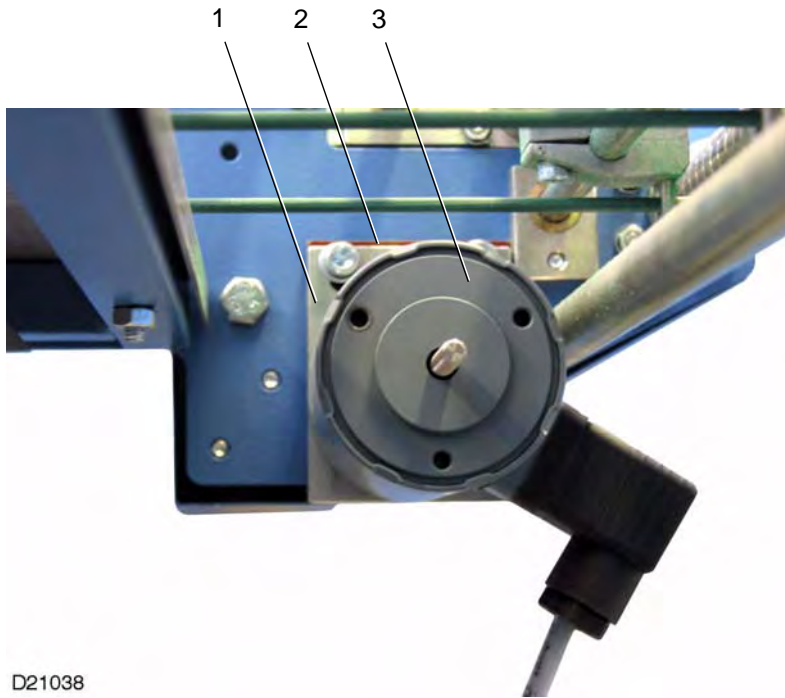

D21038

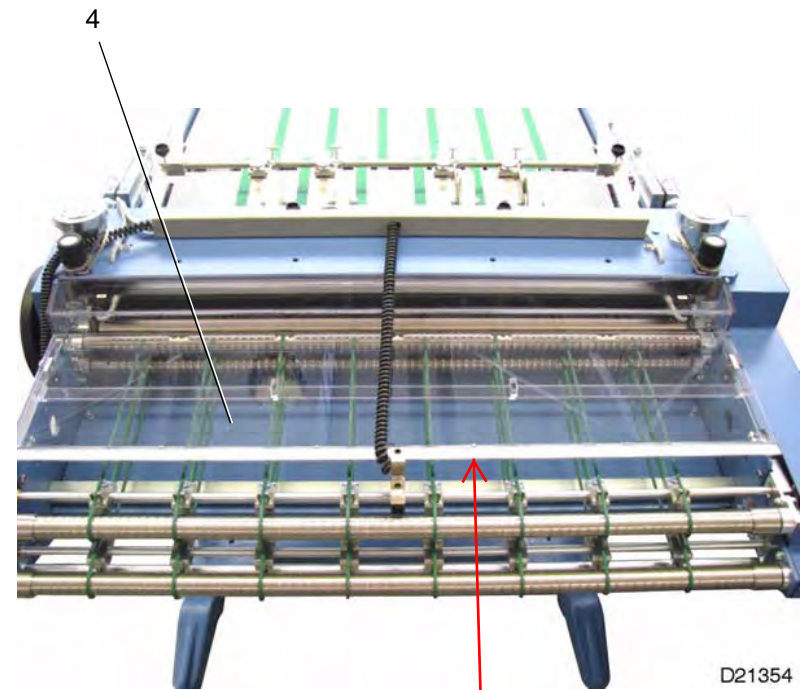

D21354

BAR FOR GUARD
83.8353.13



Schuppenauslage
Stream delivery
Sortie à nappe

ETL_ASP_66/82-2ME

Version: 1.1



7.5

Markiereinrichtung
Marking device
Compteur-décaleur



42

Pos.: Nr.: N°:	Bezeichnung	Designation	Désignation	Teile-Nr.: Partial-No.: Numéro partiel:
1	Magnetaufnahme	magnet support	porte-aimant	83.8544.61
2	Wärmeisolation Zylinderschraube Sicherungsscheibe	heat insulation allen screw safety washer	isolation thermique vis à tête cylindrique rondelle de blocage	83.8544.119 0088799.5 0101543
3	Umkehrhubmagnet Zylinderschraube Scheibe Sechskantmutter	double-way electric lifting magnet allen screw washer hexagon nut	électroaimant de levage réversible vis à tête cylindrique rondelle ecrou à six pans	0129811 0088666.5 0086108.5 0090845.5
4	Schutzhaube ASP66-2ME ASP82-2ME	guard hood ASP66-2ME ASP82-2ME	capot de protection ASP66-2ME ASP82-2ME	83.8366.05 83.8366.06

	Schuppenauslage Stream delivery Sortie à nappe	ETL_ASP_66/82-2ME	7.5	Markiereinrichtung Marking device Compteur-décaleur	
		Version: 1.1			

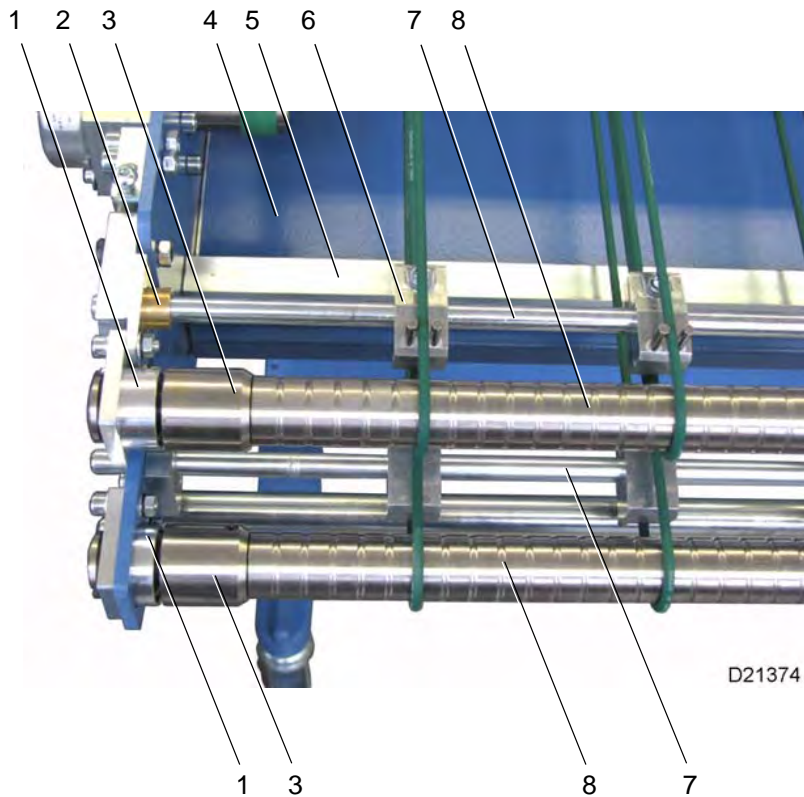

D21374

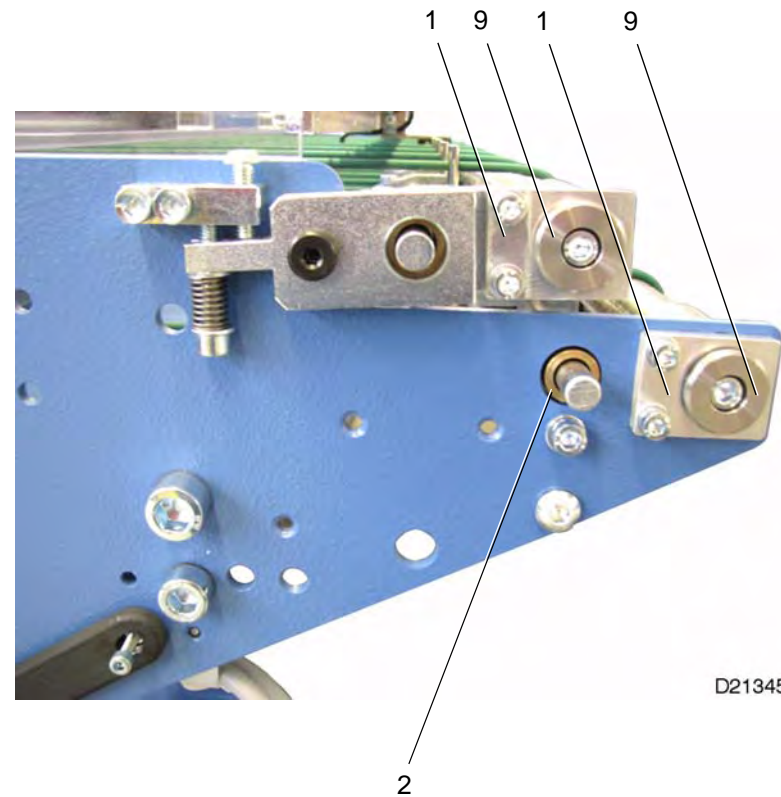

D21345



Schuppenauslage
Stream delivery
Sortie à nappe

ETL_ASP_66/82-2ME

Version: 1.1

7.5

Markiereinrichtung
Marking device
Compteur-décaleur



Pos.: Nr.: N°:	Bezeichnung	Designation	Désignation	Teile-Nr.: Partial-No.: Numéro partiel:
1	Lagerflansch Bolzen Zylinderschraube Scheibe Sechskantmutter	bearing flange pin allen screw washer hexagon nut	flasque de support axe vis à tête cylindrique rondelle ecrou à six pans	36.8544.20 83.8525.26 0088674.5 0086108.5 0090845.5
2	Buchse	socket	connecteur femelle	83.8526.09
3	Lagerbuchse Kugellager Spannstift	bearing bush ball bearing spring pin	douille de palier roulement à billes goupille élastique	83.8526.25 0109611 0094941
4	Schutzblech ASP66-2ME ASP82-2ME	guard plate ASP66-2ME ASP82-2ME	tôle de protection ASP66-2ME ASP82-2ME	83.8361.30 83.8361.32
5	Traverse ASP66-2ME ASP82-2ME	cross bar ASP66-2ME ASP82-2ME	traverse ASP66-2ME ASP82-2ME	83.8341.38 83.8341.53
6	Klemmstück Zylinderschraube	calmping piece allen screw	pièce de serrage vis à tête cylindrique	83.8544.87 0088658.5
7	Stange ASP66-2ME ASP82-2ME	rod ASP66-2ME ASP82-2ME	barre ASP66-2ME ASP82-2ME	83.8521.60 83.8500.31
8	Welle kpl. ASP66-2ME ASP82-2ME	shaft cpl. ASP66-2ME ASP82-2ME	arbre cpl. ASP66-2ME ASP82-2ME	83.8500.102 83.8500.103
9	Scheibe	washer	rondelle	83.8528.22

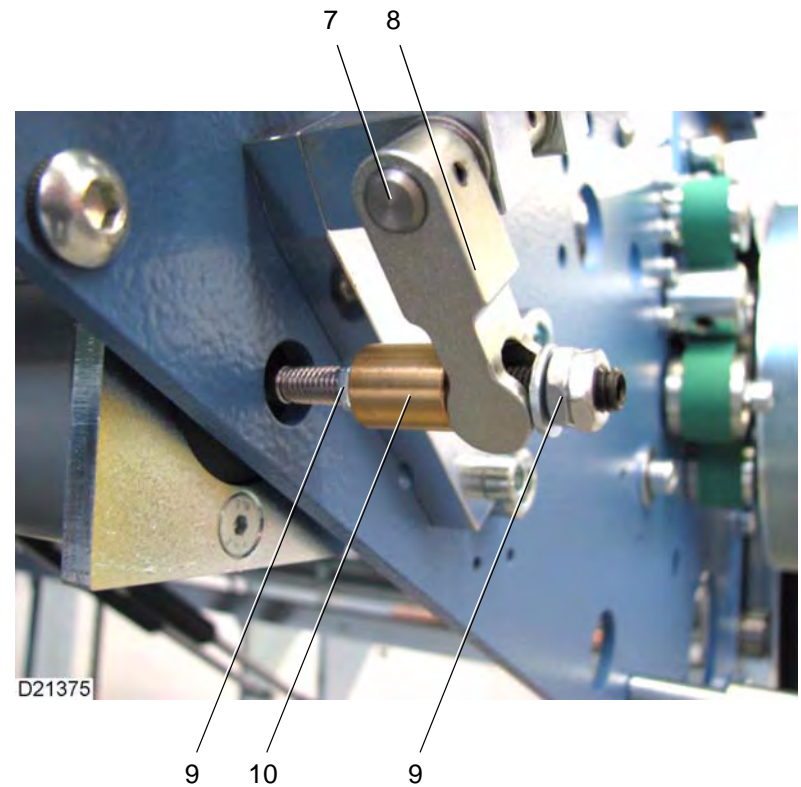
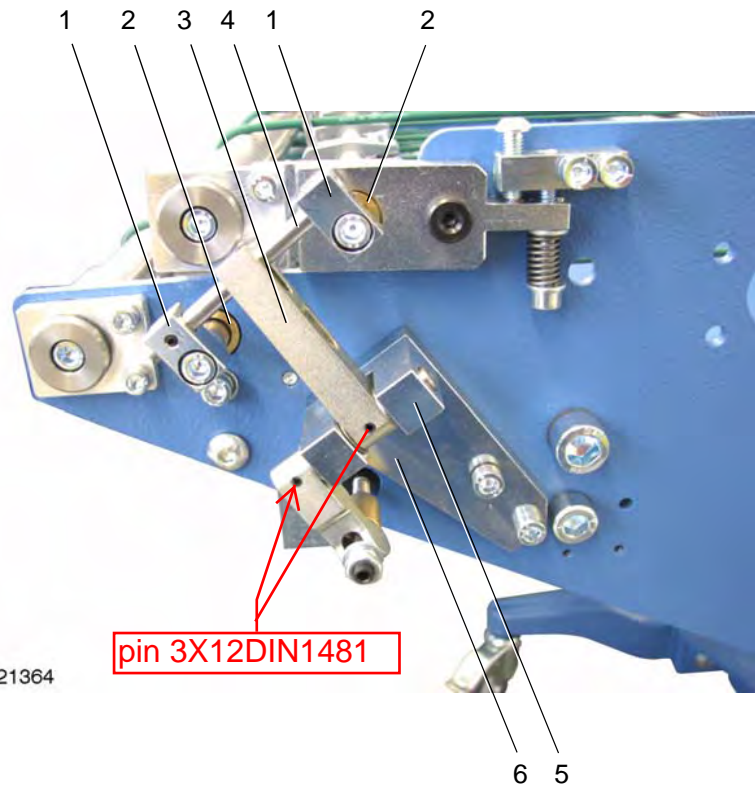

Schuppenauslage
Stream delivery
Sortie à nappe

ETL_ASP_66/82-2ME



Version: 1.1

7.5

Markiereinrichtung
Marking device
Compteur-décaleur



Pos.: Nr.: N°:	Bezeichnung	Designation	Désignation	Teile-Nr.: Partial-No.: Numéro partiel:
	Markiereinrichtung	marking device	compteur-décaleur	83.8500.60
1	Schiebeklotz	slide block	bloc de guidage	83.8544.94
2	Buchse	socket	connecteur femelle	83.8526.09
3	Schubhebel	push lever	bielle	83.8544.95
4	Schiebeachse	sliding shaft	bielle	83.8525.22
5	Lager	bearing	palier	83.8544.93
6	Lagerplatte	bearing plate	plaque de support	83.8544.92
7	Achse	shaft	axe	83.8525.23
8	Anlenkhebel	drop arm	levier	83.8544.96
9	Sechskantmutter	hexagon nut	écrou à six pans	0092123.5
10	Kupplungsstück	coupling piece	douille d'embrayage	83.8528.20

	Schuppenauslage Stream delivery Sortie à nappe	ETL_ASP_66/82-2ME	7.5	Markiereinrichtung Marking device Compteur-décaleur	
		Version: 1.1			

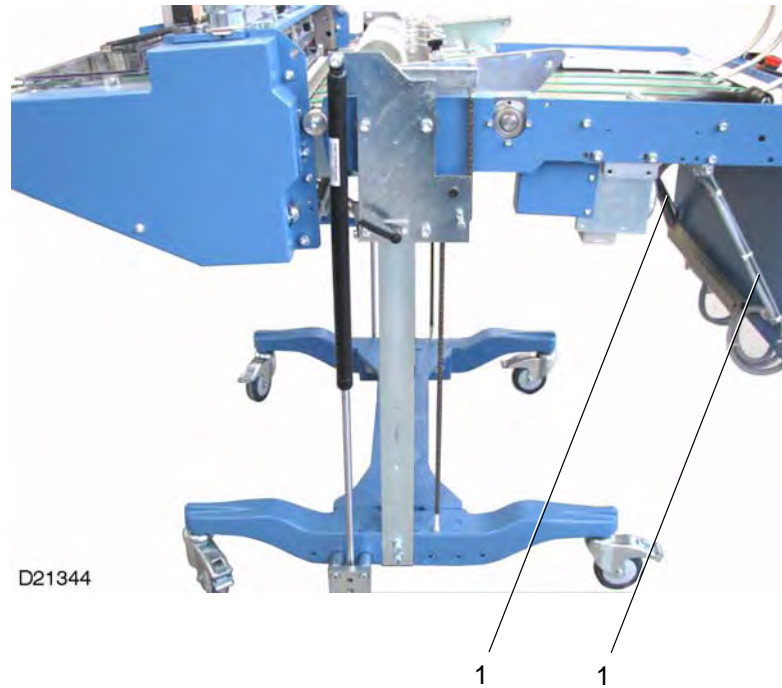

D21344

1

1



Schuppenauslage
Stream delivery
Sortie à nappe

ETL_ASP_66/82-2ME

Version: 1.1

7.6

Anbauteile Schaltkasten
Add-on parts control box
Pièces d'assemblage boîte de commande



48

Pos.: Nr.: N°:	Bezeichnung	Designation	Désignation	Teile-Nr.: Partial-No.: Numéro partiel:
1	Strebe für Schaltschrank Zylinderschraube Scheibe	strut for control cabinet allen screw washer	tirant pour armoire électrique vis à tête cylindrique rondelle	17.7360.04 0088799.5 0095661.5

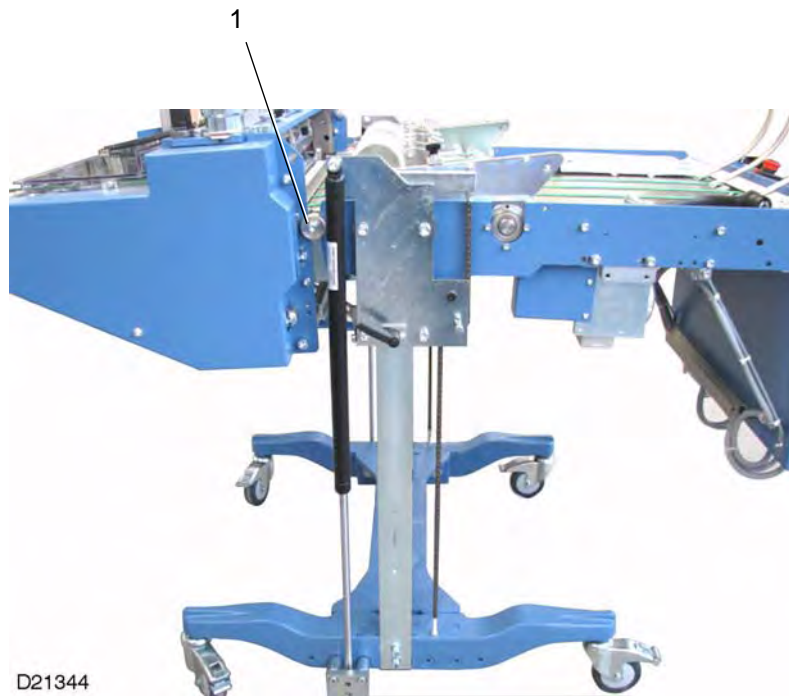

D21344

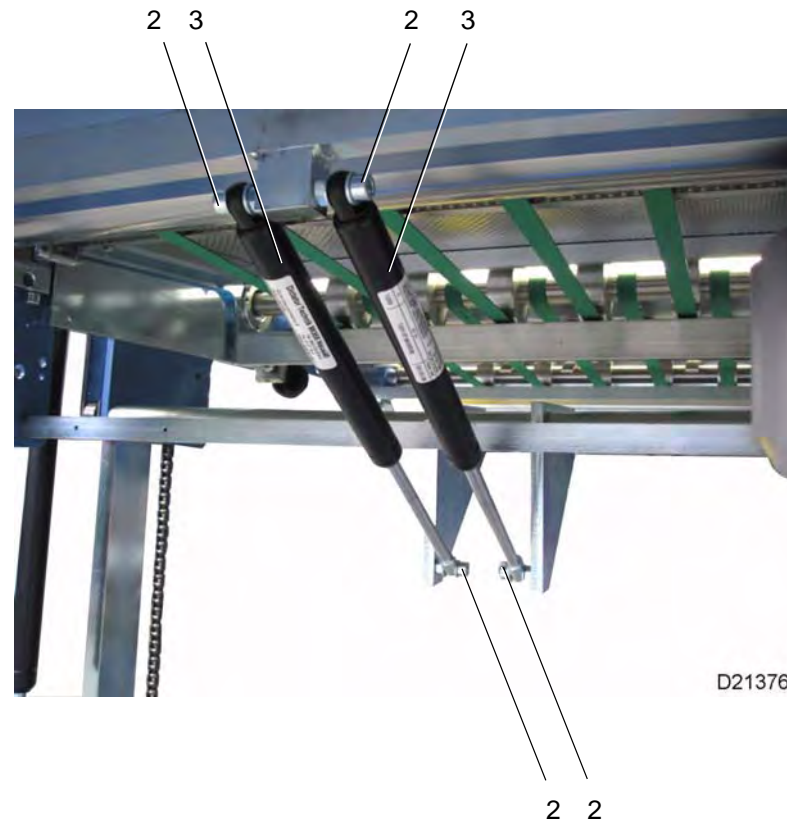

D21376



Schuppenauslage
Stream delivery
Sortie à nappe

ETL_ASP_66/82-2ME

Version: 1.1

7.7



Höheneinstellung Einlauf
Height adjustment infeed
Réglage en hauteur entrée

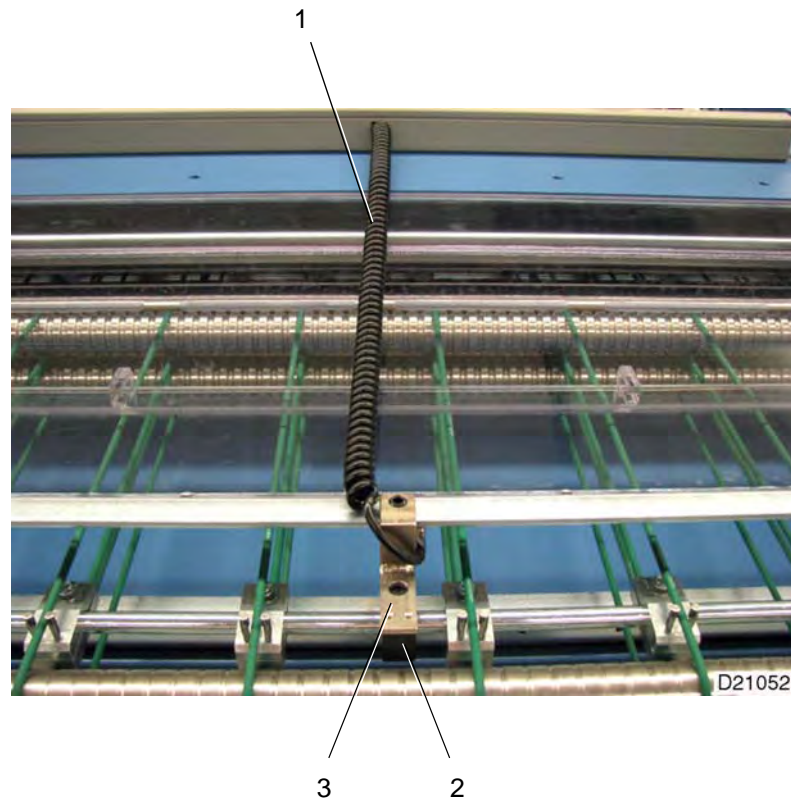

Pos.: Nr.: N°:	Bezeichnung	Designation	Désignation	Teile-Nr.: Partial-No.: Numéro partiel:
1	Klemmstück Zylinderschraube	clamping piece allen screw	pièce de serrage vis à tête cylindrique	81.8528.22 0089045.5
2	Zylinderschraube	allen screw	vis à tête cylindrique	0094813.5
3	Gasdruckfeder	pneumatic spring	ressort pneumatic	0100137



Pos.: Nr.: N°:	Bezeichnung	Designation	Désignation	Teile-Nr.: Partial-No.: Numéro partiel:
	Lichtschanke am Einlauf	light barrier at infeed	barrière lumineuse au entrée	83.1299.410
1	Spiralkabel	helix cable	câble spiralé	0601419 1.6.1099.88
2	Reflexionslichtschanke	reflex light barrier	barrière lumineuse réflexe	1322999
3	Halter für Lichtschanke Zylinderschraube Scheibe	support for light barrier allen screw washer	support pour barrière lumineuse vis à tête cylindrique rondelle	83.8364.54 0085704.5 0086082.5

	Schuppenauslage Stream delivery Sortie à nappe	ETL_ASP_66/82-2ME	7.8	Lichtschanke am Einlauf Light barrier at infeed Barrière lumineuse au entrée	
		Version: 1.1			

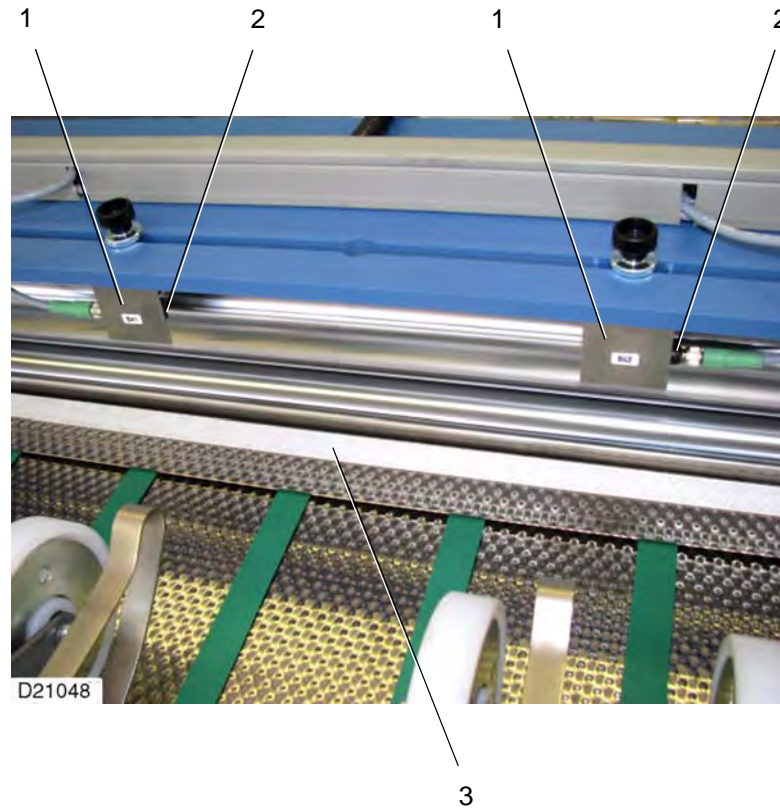

Schuppenauslage
Stream delivery
Sortie à nappe

ETL_ASP_66/82-2ME



Version: 1.1

7.9

Lichtschranke Auslauf Pressstation
Light barrier at outlet press station
Barrière lumineuse sortie de poste de pression



Pos.: Nr.: N°:	Bezeichnung	Designation	Désignation	Teile-Nr.: Partial-No.: Numéro partiel:
1	Halter für Lichtschranke kpl. Halter für Lichtschranke Klemmstück Rändelhohlschraube Rändelmutter	support for light barrier cpl. support for light barrier clamping piece knurled screw knurled nut	support pour barrière lumineuse support pour barrière lumineuse pièce de serrage vis moletée ecrou moletée	83.8300.122 83.8362.032 83.8362.19 0095802 0087130.5
2	Reflexions-Lichtschranke	photocell	détecteur réflexe	0131576
3	Reflexfolie ASP66-2ME ASP82-2ME	film ASP66-2ME ASP82-2ME	film de réflexion ASP66-2ME ASP82-2ME	81.8371.000 81.8371.001

	Schuppenauslage Stream delivery Sortie à nappe	ETL_ASP_66/82-2ME	7.9	Lichtschranke Auslauf Pressstation Light barrier at outlet press station Barrière lumineuse sortie de poste de pression	
		Version: 1.1			

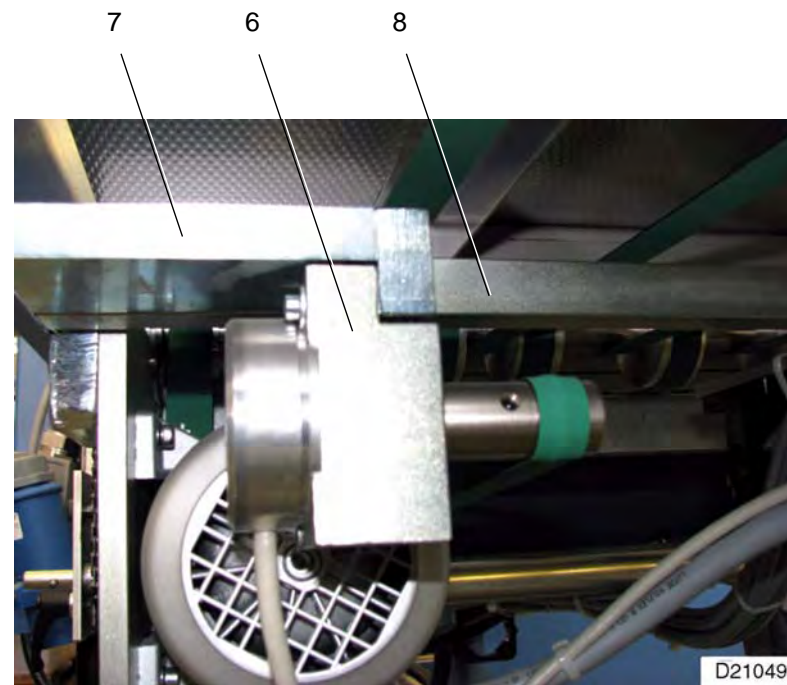
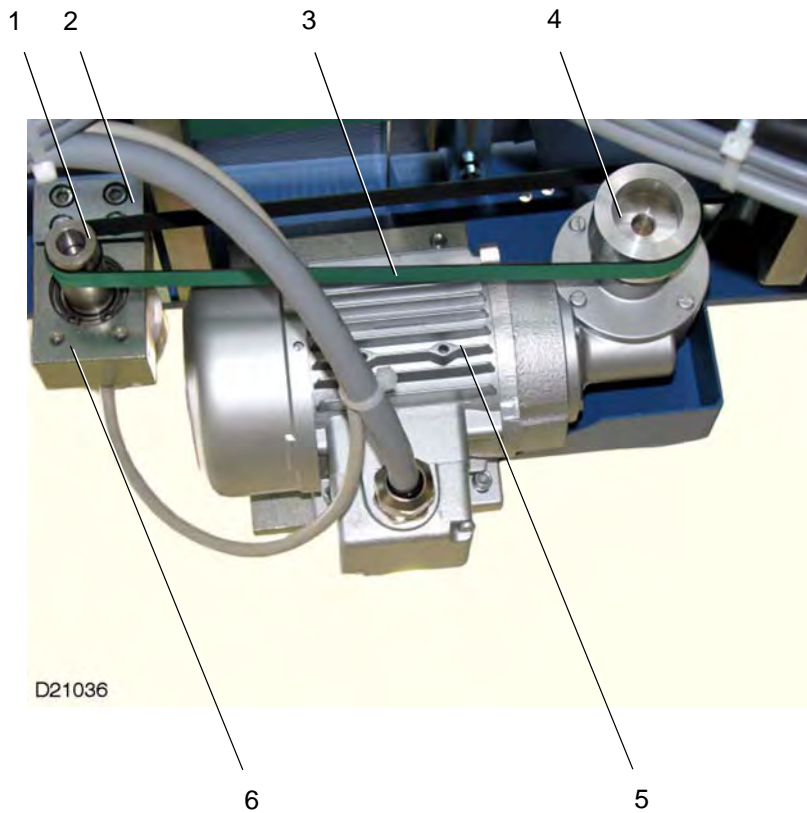

Schuppenauslage
Stream delivery
Sortie à nappe

ETL_ASP_66/82-2ME

Version: 1.1

7.10

Sondereile Navigator
Special parts Navigator
Pièces spécial Navigator



Pos.: Nr.: N°:	Bezeichnung	Designation	Désignation	Teile-Nr.: Partial-No.: Numéro partiel:
	Sonderteile Navigator	special parts Navigator	pièces spécial Navigator	81.8500.127
1	Buchse O-Ring Gewindestift	socket O-seal grub screw	connecteur femelle joint torique goupille fileté	83.8526.029 1282391 0089516
2	Befestigungslasche	bracket	plaque de fixation	81.8544.093
3	Band	tape	bande	1337633
4	Riemenscheibe Gewindestift	pulley grub screw	poulie goupille fileté	81.8532.025 0089615
5	Motor	motor	moteur	0104067
6	Drehgeber kpl. Drehgeber Halter Kugellager Sicherungsring Welle Sicherungsring Passscheibe Passscheibe	encoder cpl. encoder support ball bearing circlip shaft circlip shim ring shim ring	codeur cpl. codeur support roulement à billes circlip arbre circlip rondelle d'ajustage rondelle d'ajustage	17.5200.82 0131593 17.5244.13 0109778 0087478 17.5221.11 0087205 0092292 0092292
7	Verlängerung	extension	rallonge	81.8544.092
8	Traverse	cross bar	traverse	81.8541.48

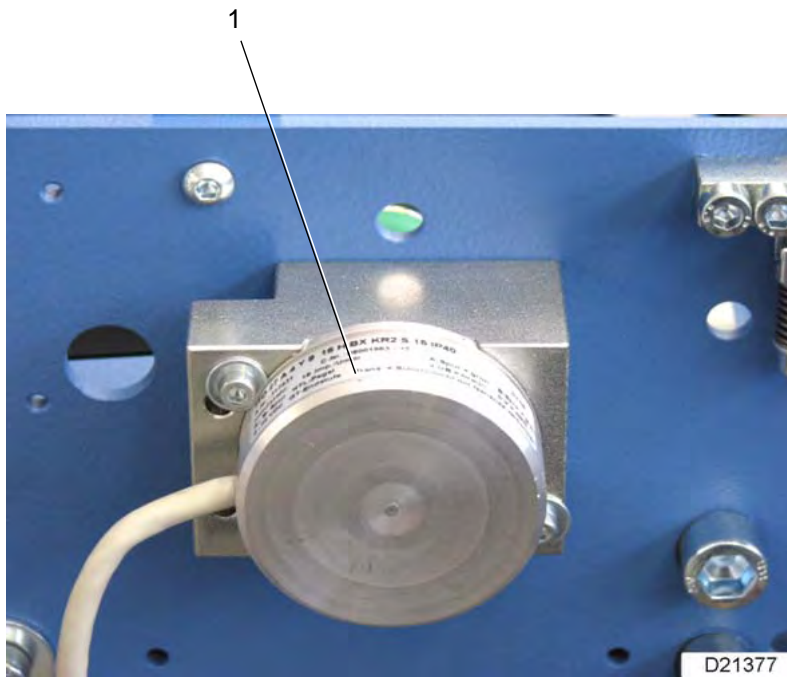

D21377

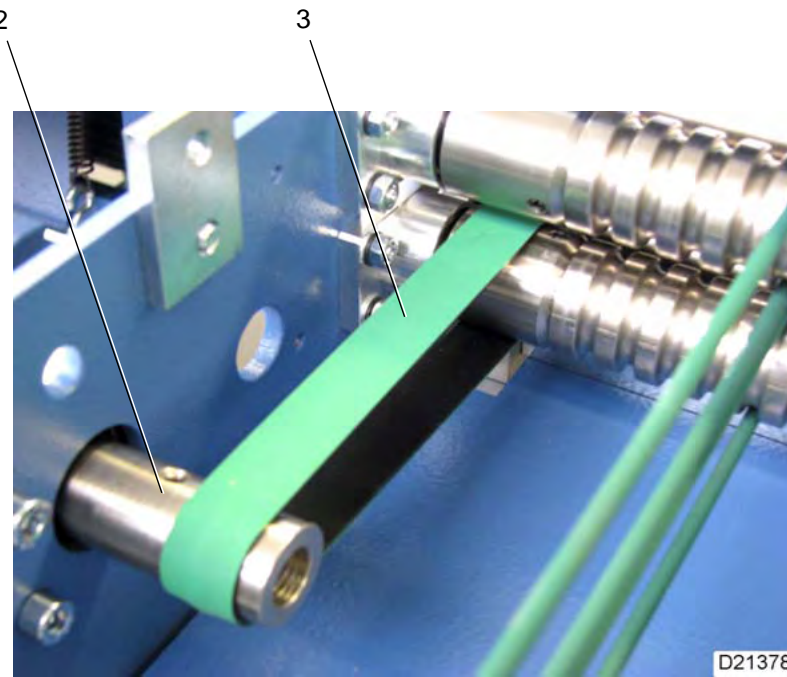

D21378



Schuppenauslage
Stream delivery
Sortie à nappe

ETL_ASP_66/82-2ME

Version: 1.1

7.10

Sonderteile Navigator
Special parts Navigator
Pièces spécial Navigator



58

Pos.: Nr.: N°:	Bezeichnung	Designation	Désignation	Teile-Nr.: Partial-No.: Numéro partiel:
1	Drehgeber kpl. Drehgeber Halter Kugellager Sicherungsring Welle Sicherungsring Passscheibe Passscheibe	encoder cpl. encoder support ball bearing circlip shaft circlip shim ring shim ring	codeur cpl. codeur support roulement à billes circlip arbre circlip rondelle d'ajustage rondelle d'ajustage	17.5200.82 0131593 17.5244.13 0109778 0087478 17.5221.11 0087205 0092292 0092297
2	Buchse O-Ring Gewindestift	socket O-seal grub screw	connecteur femelle joint torique goupille filetée	83.8526.029 1282391 0089516
3	Band	tape	bande	1279959

MBO-Gruppe weltweit/ MBO group worldwide/ Le groupe MBO mondial

MBO Deutschland

MBO Maschinenbau Oppenweiler Binder GmbH & Co. KG
Postfach 1169
71567 Oppenweiler
DEUTSCHLAND
Tel.: +49 7191 46 0
Fax: +49 7191 46 34
<http://www.mbo-folder.com>
info@mbo-folder.com

MBO Portugal

MBO Binder-Maquinas Graficas, S.A.
Rua Joaquim Alves da Silva 240
4456-473 Perafita
PORTUGAL
Tel.: +351 22 99822 00
Fax: +351 22 99822 01
<http://www.mbo-folder.com>
info@mbo-folder.com

MBO Amerika

MBO Binder & Co. of America
400 Highland Drive
Westampton, NJ 08060
USA
Tel.: +1 609 267 2900
Fax: +1 609 267 1477
<http://www.mboamerica.com>
info@mboamerica.com

MBO Frankreich

MBO France SAS
Z. A. Burospace N° 3
Route de Gisy B.P. 33
91571 Bievres Cedex
FRANCE
Tel.: +33 1 6935 5090
Fax: +33 1 6935 5099
<http://www.mbo-folder.com>
info@mbofrance.fr

MBO China

MBO Binder Graphic Systems (Beijing) Co. Ltd.
No.3 Building, Xing Sheng Industry Park,
No.7 Tong Ji Zhong Lu, BDA,
Beijing 100176
P.R. CHINA
Tel.: +86 10 6786 2741
Fax: +86 10 6786 2743
<http://www.mbo-folder.com.cn>

Herzog & Heymann

Herzog & Heymann GmbH + Co. KG
Postfach 110355
33663 Bielefeld
DEUTSCHLAND
Tel.: +49 5205 7509 0
Fax: +49 5205 7509 20
<http://www.herzog-heyman.com>
info@herzog-heyman.com