

Ersatzteilliste T 49 - 55

Spare part list T 49 - 55

Liste de pièces de rechange T 49 - 55

guard
1.0.5161.070 nos
1.0.5161.080 os
(not drive plate)

1.0.5125.030 bolt

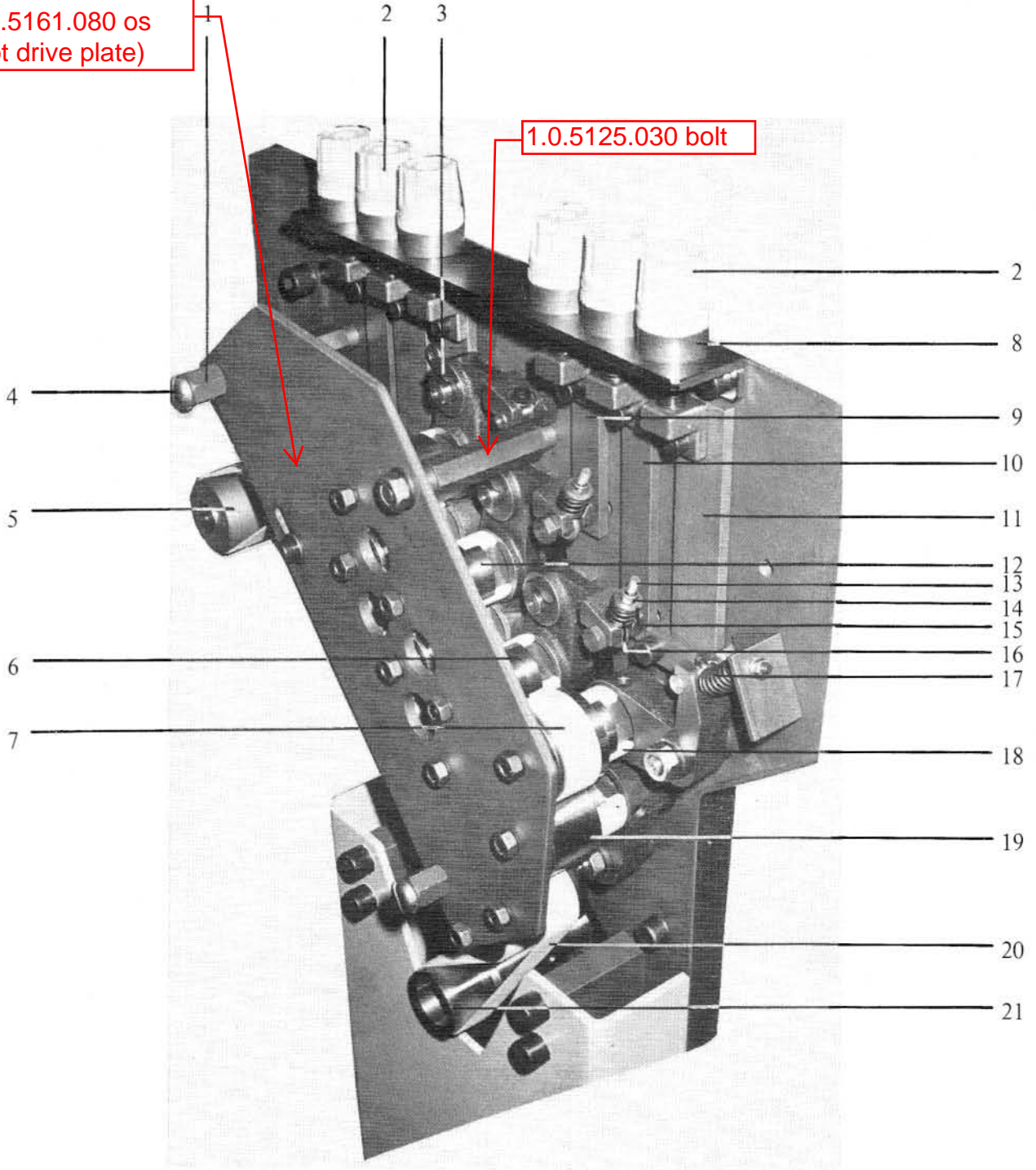

1	Distanzstück	Distance part	Distance pièces	1.0.5129 010	
2	Stellmutter	Adjustment nut	Ecrou de réglage	1.0.5416 010	
3	Sicherung	Circlips	Circlips	1009000012	
4	Schraube	Screw	Vis	M 10 x 12 DIN 85	
5	Bandrolle	Tape roller	Roulette	1.0.5232 020	
6	Bandrolle	Tape roller	Roulette	1.0.5232 030 mit	
			Lager	F 80 941 INA	
7	Bandrolle	Tape roller	Roulette	1.0.5232 040 mit	
			Lager	F 80 941 INA	
8	Dinstanzring	Distance part	Distance pièces	1.0.5428 010	
9	Stellstück	Adjustment part	Pièces de réglage	1.0.5464 010	
10	Stellstück	Adjustment part	Pièces de réglage	1.0.5464 030	
11	Stellstück	Adjustment part	Pièces de réglage	1.0.5464 090	
12	Bandrolle	Tape roller	Roulette	1.0.5232 030 mit	
			Lager	F 80 941 INA	
13	Federhaken	Spring hook	Crochet pour ressort	3.0.5425 010	} cpl. VM 0163
14	Mutter	Nut	Ecron	M 5 DIN 985	
15	Scheibe	Washer	Rondelle	3.0.5426 010	
16	Druckfeder	Spring	Ressort	D 218	
17	Druckfeder	Spring	Ressort	60 480 060	
18	Kupplungsstück	Coupling part	Pièce d'accouplement	1.0.5216 010	
19	Bandrolle	Tape roller	Roulette	1.0.5232 040 mit	
			Lager	F 80 941 INA	
20	Flachriemen	Flat belt	Cordon	25 x 1750 pu 11	
21	Bandrolle	Tape roller	Roulette	1.0.5232 010	

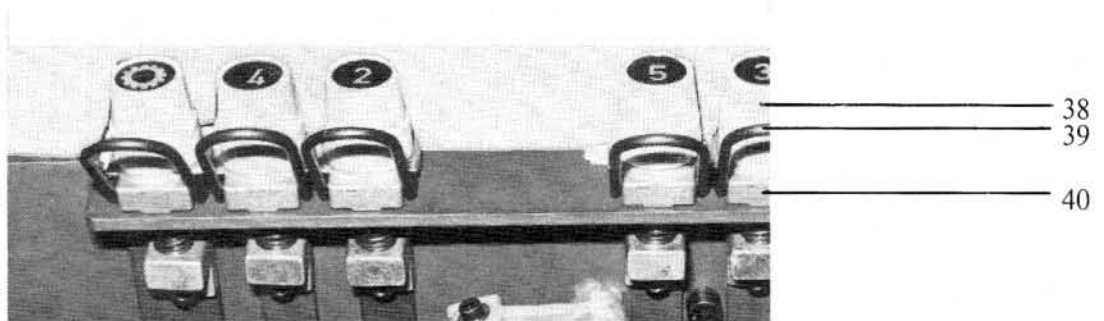
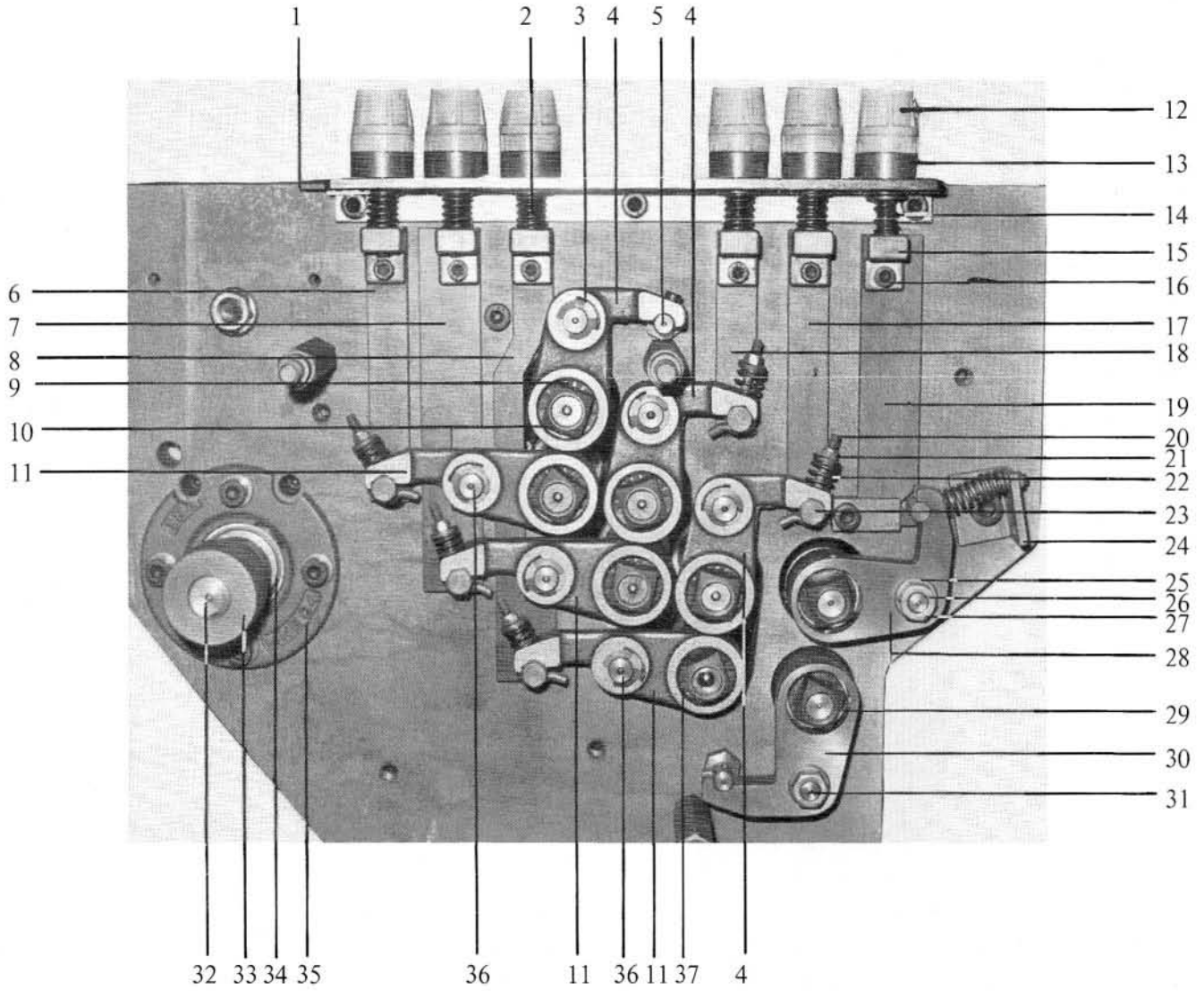

1	Scheibe	Washer	Rondelle	10,5 DIN 125	
2	Druckfeder	Spring	Ressort	D 252 A-02	
3	Sicherung	Circlip	Circlips	1009000012	
4	Lagerhebel	Lever	Levier	1.0.5312 050	
5	Bolzen	Bolt	Axe	1.0.5325 050	
6	Abdrückleiste	Adjustment bar	Tige de pression	1.0.5464 020	
7	Abdrückleiste	Adjustment bar	Tige de pression	1.0.5464 050	
8	Abdrückleiste	Adjustment bar	Tige de pression	1.0.5464 060	
9	Tellerfeder	Disc spring	Ressort	6002 geschl.	
10	Kupplungsstück	Coupling part	Noix fixe	1.0.5326 311	
11	Lagerhebel	Bearing lever	Levier	1.0.5312 070	
12	Stellmutter	Adjustment nut	Vis de réglage	1.0.5416 010	
13	Distanzring	Distance ring	Distance pièces	1.0.5428 010	
14	Druckfeder	Spring	Ressort	D 150 B	
15	Halter	Holder	Support	1.0.5415 010	
16	Schraube	Screw	Vis	M 5 x 10 DIN 912	
17	Abdrückleiste	Adjustment bar	Tige de pression	1.0.5464 030	
18	Abdrückleiste	Adjustment bar	Tige de pression	1.0.5464 010	
19	Abdrückleiste	Adjustment bar	Tige de pression	1.0.5464 090	
20	Federhaken	Spring hook	Crocket pour ressort	3.0.5425 010	} cpl. VM 163
21	Mutter	Nut	Ecrou	M 5 DIN 985	
22	Druckfeder	Spring	Ressort	D 218	
23	Bolzen	Bolt	Axe	1.0.5425 010	
24	Federwinkel	Spring angle	Crocket pour ressort	1.0.5143 060	
25	Scheibe	Washer	Rondelle	10.4 DIN 125	
26	Bolzen	Bolt	Axe	1.0.5325 070	
27	Mutter	Nut	Ecrou	M 10 DIN 934	
28	Lagerhebel	Lever	Levier	1.0.5312 010	
29	Kugellager	Ball bearing	Roulement	6002 - 2 RS	
30	Lagerhebel	Lever	Levier	1.0.5312 030	
31	Bolzen	Bolt	Axe	1.0.5325 070	
32	Welle	Shaft	Arbre	1.5.5221 040	
33	Bandrolle	Tape roller	Roulette	1.0.5232 020	
34	Kugellager	Ball bearing	Roulement	PM NE 20 INA	
35	Lagerflansch	Bearing block	Fiasque	1.0.5227 010	
36	Lagerbolzen	Bearing bolt	Axe	1.0.5325 060	
37	Kugellager	Ball bearing	Roulement	6002-2 RS	
38	Stellmutter	Adjustment nut	Vis de réglage	1.0.5416 010*	
39	Abdrückbügel	Adjustment lever	Tige de pression	2.0.5486 010*	
40	Stellstück	Adjustment part	Pièces de réglage	2.0.5415 010*	

*nur bei Walzen-Schnelleinstellung

*only by speed roller adjustment

*seulement avec le réglage rapide des cylindres

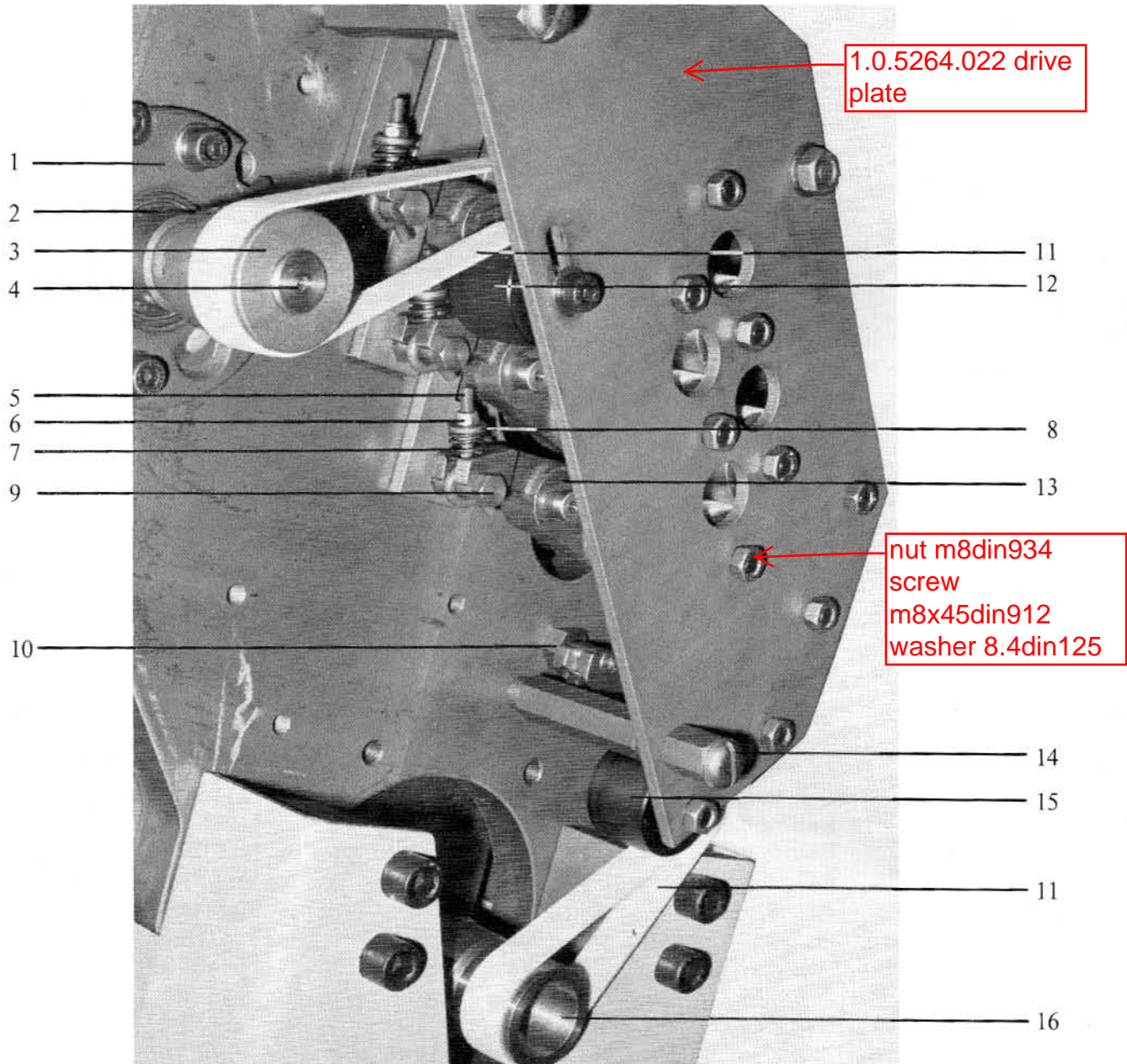

1	Lagerflansch	Bearing block	Flasque	1.0.5227 010	
2	Kugellager	Ball bearing	Roulement	PM NE 20 INA	
3	Bandrolle	Tape roller	Roulette	1.0.5232 020	
4	Welle	Shaft	Arbre	1.5.5221 040	
5	Federhaken	Spring hook	Crochet pour ressort	3.0.5425 010	} cpl. VM 163
6	Mutter	Nut	Ecrou	M 5 DIN 985	
7	Druckfeder	Spring	Ressort	D 218	
8	Scheibe	Washer	Rondelle	3.0.5426 010	
9	Bolzen	Bolt	Axe	1.0.5425 010	
10	Bolzen	Bolt	Axe	1.0.5325 050	
11	Flachriemen	Flat belt	Cordon	24 x 1750 pu 11	
12	Bandrolle	Tape roller	Roulette	INA V 56 202	
13	Sicherung	Washer	Circlips	12 SXN 09	
14	Schraube	Screw	Vis	M 10 x 12 DIN 85	
15	Bandrolle	Tape roller	Roulette	INA V 56 202	
16	Bandrolle	Tape roller	Roulette	1.0.5232 010	

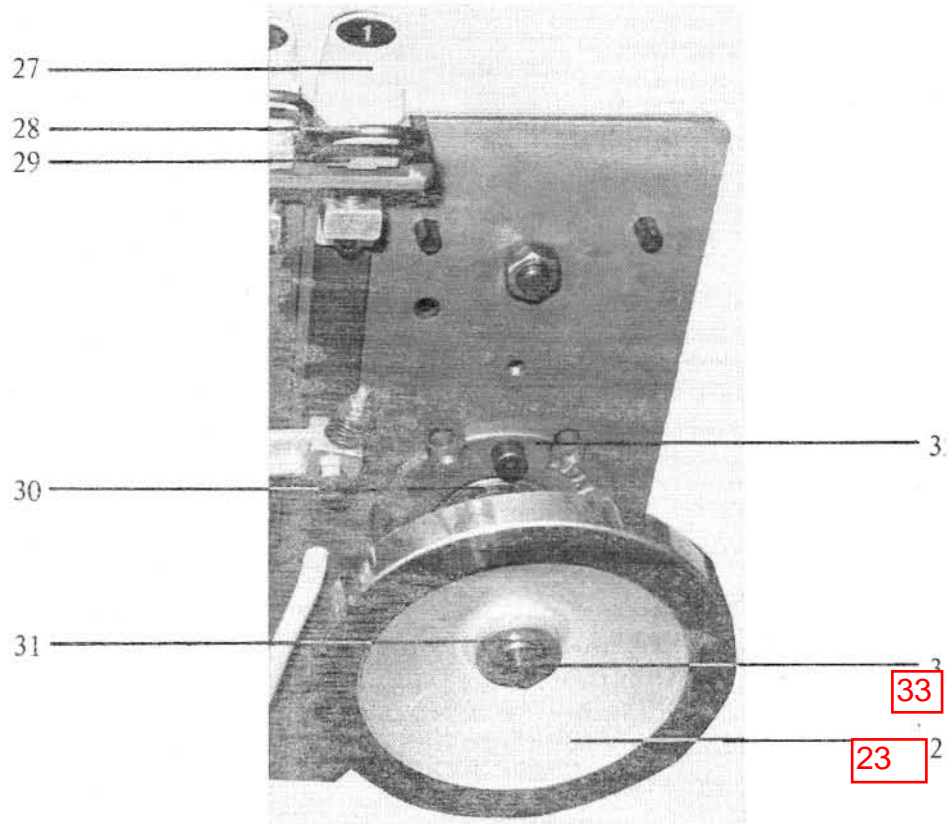
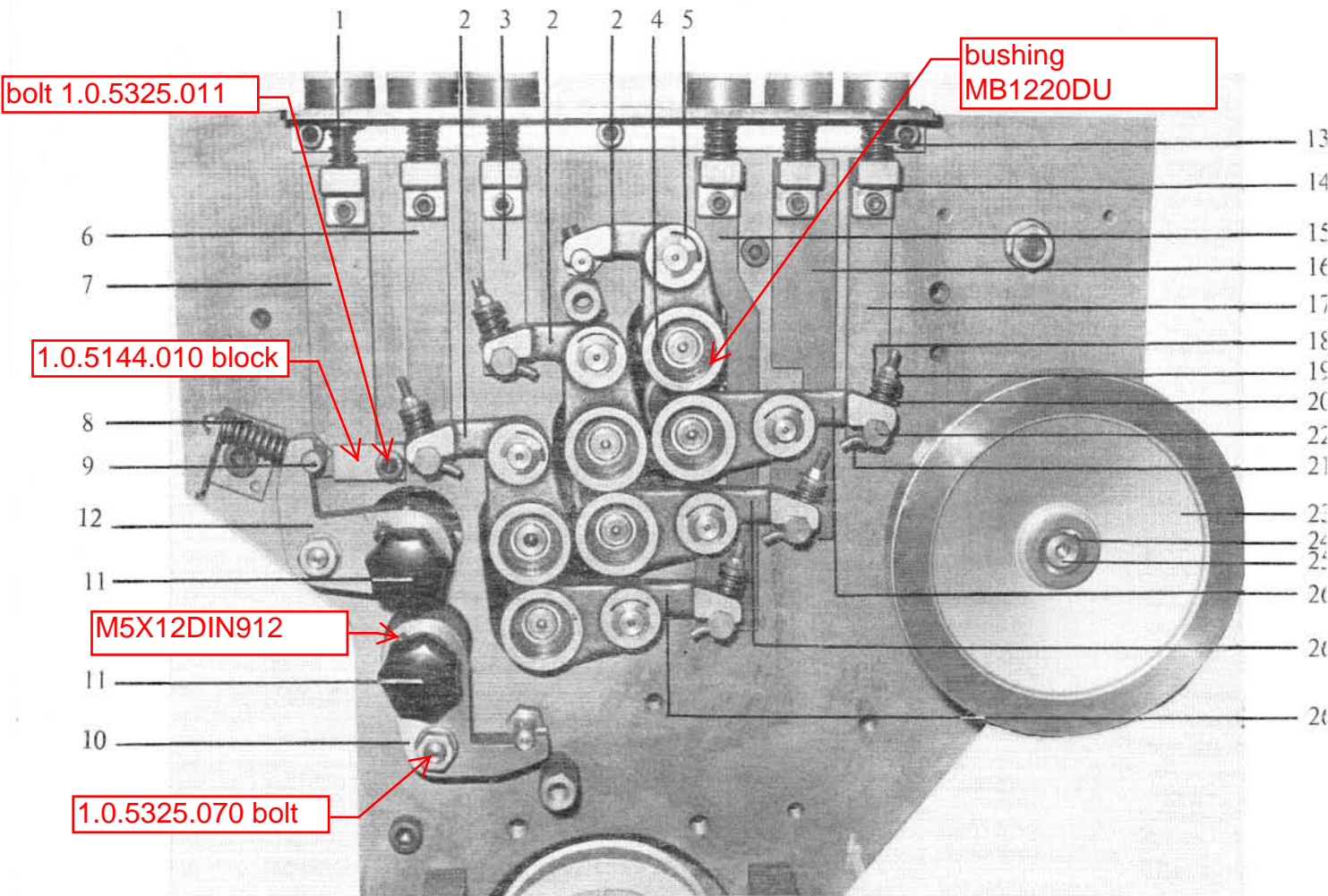

1	Druckfeder	Spring	Ressort	D 150 B
2	Lagerhebel	Bearing lever	Levier	1.0.5312 060
3	Abdrückleiste	Adjustment bar	Tige de pression	1.0.5464 010
4	Kugellager	Ball bearing	Roulement	6002 - 2 RS
5	Sicherung	Circlip	Circlip	1009000012
6	Abdrückleiste	Adjustment bar	Tige de pression	1.0.5464 030
7	Abdrückleiste	Adjustment bar	Tige de pression	1.0.5464 090
8	Druckfeder	Spring	Ressort	60 480 060
9	Bolzen	Bolt	Axe	1.0.5325 050
10	Lagerhebel	Bearing lever	Levier	1.0.5312 020
11	Steckachse	Bolt	Axe	1.0.5325 080
	Sterngriff	Stargripp	Poignee	mit-with-avec- K 40 x M 8 DIN 6336
12	Lagerhebel	Bearing lever	Levier	1.0.5312 040
13	Druckfeder	Spring	Ressort	D 252 A - 02
14	Halter	Holder	Support	1.0.5415 010
15	Abdrückleiste	Adjustment bar	Tige de pression	1.0.5464 060
16	Abdrückleiste	Adjustment bar	Tige de pression	1.0.5464 050
17	Abdrückleiste	Adjustment bar	Tige de pression	1.0.5464 020
18	Scheibe	Washer	Rondelle	3.0.5426 010
19	Mutter	Nut	Ecrou	M 5 DIN 985
20	Druckfeder	Spring	Ressort	D 218
21	Federhaken	Spring hook	Crochet pour ressort	3.0.5425 010
22	Bolzen	Bolt	Axe	1.0.5425 010
23	Handrad	Handwheel	Volant	Zi 160 x 16
24	Paßfeder	Key	Clavette	6 x 4 x 20 DIN 6885
25	Welle	Shaft	Arbre	1.5.5221 040
26	Lagerhebel	Bearing lever	Levier	1.0.5312 080
27	Stellmutter	Adjustment nut	Ecrou de réglage	1.0.5416 010
28	Abdrückbügel	Adjustment lever	Levier câlage cylindre	2.0.5486 010
29	Stellstück	Adjustment part	Palier	2.0.5415 010
30	Kugellager	Ball bearing	Roulement	PM NE 20
31	Scheibe	Washer	Rondelle	6.4 DIN 9021
32	Lagerflansch	Bearing block	Palier	1.0.5227 010
33	Schraube	Screw	Vis	M 6 x 16 DIN 912

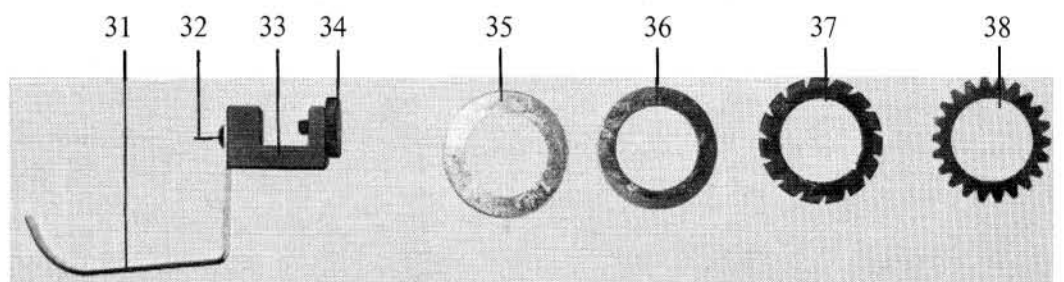
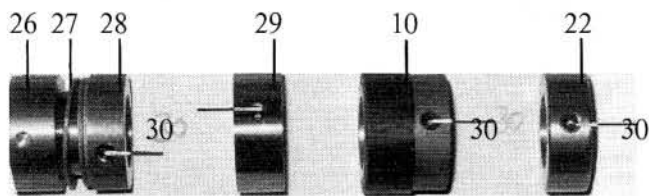
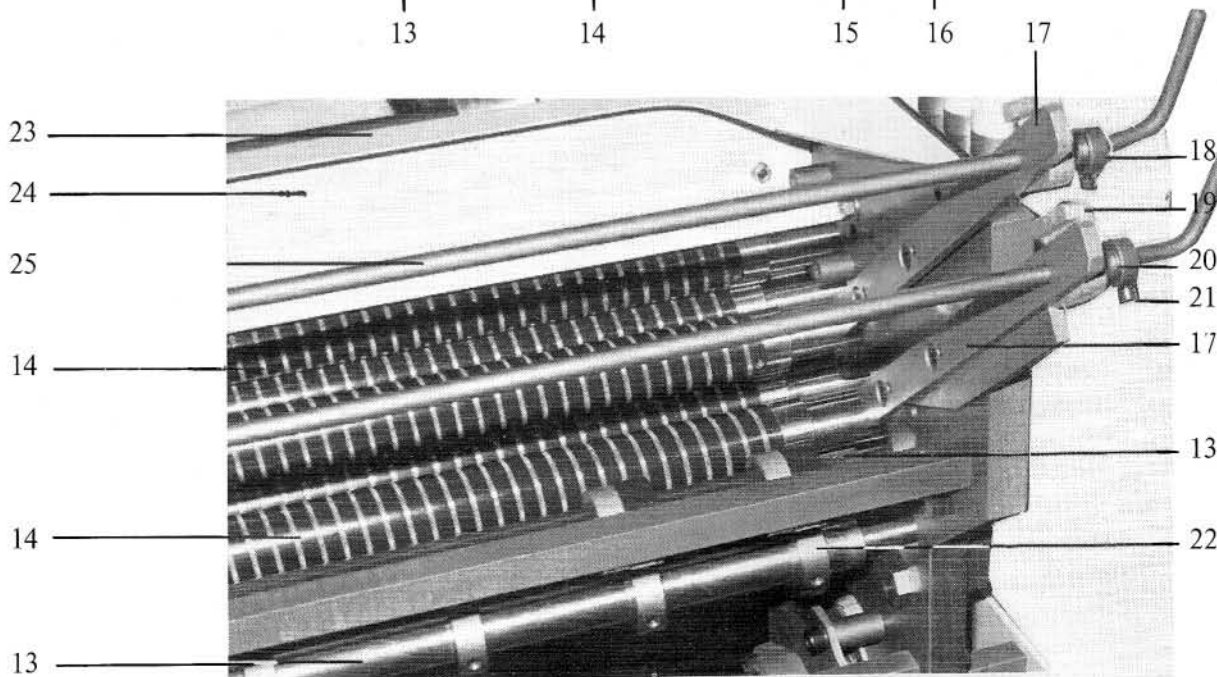
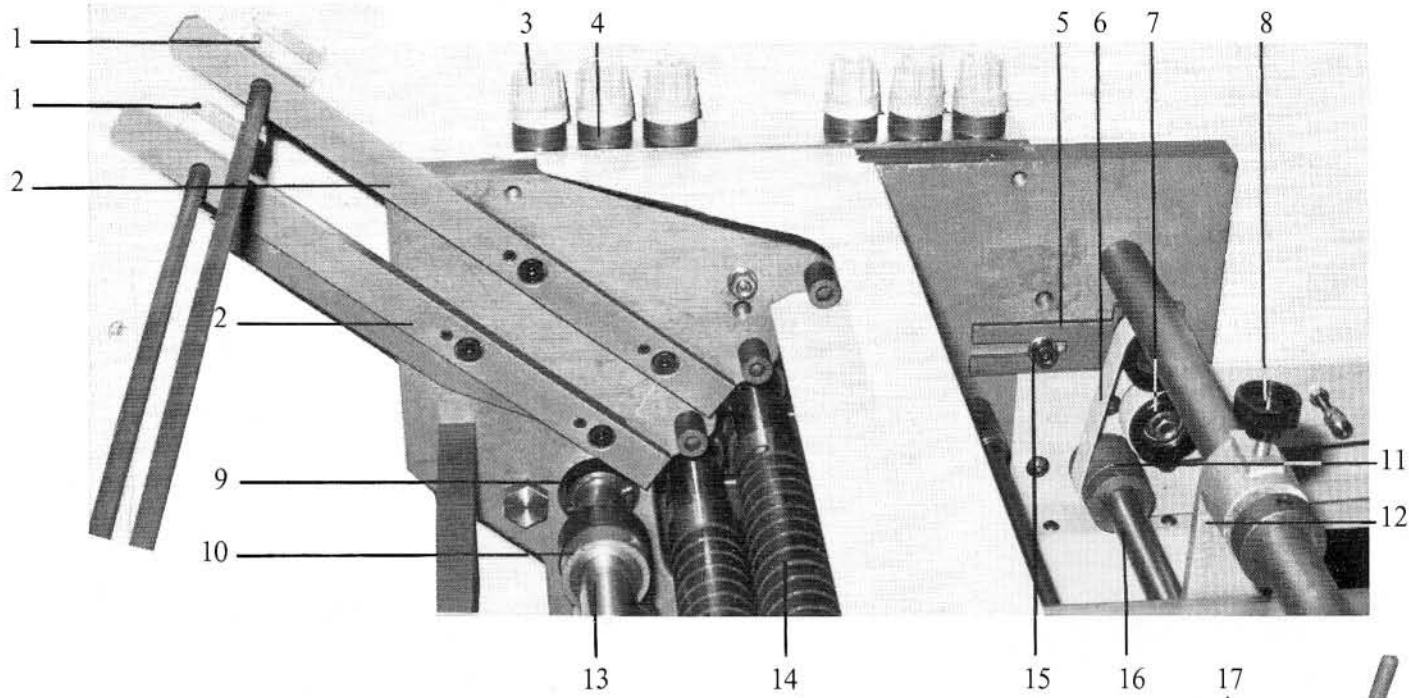

1	Klemmstück	Clamp	Support	1.0.5115 361
2	Taschenleiste	Buckle bar	Barre à Poches	2.0.5644 010
3	Stellmutter	Adjustment nut	Ecrou de réglage	1.0.5416 010
4	Distanzring	Distance	Distance	1.0.5428 010
5	Halter	Holder	Support	1.0.5264 060
6	Flachriemen	Flat belt	Cordon	20 x 1 x 2010
7	Bandrolle	Tape roller	Roulette	INA V 56 202
8	Rändelhohlschraube	Knurled screw	vis moletée	M 8 x 20 GN 421
9	Lagerbolzen	Bolt	Axe	1.0.5325 040
10	Transportrolle	Roller	Roulette de Transport	2.0.5339 010/020
11	Bandrolle	Tape roller	Roulette	1.0.5232 020
12	Stellstück	Adjustment part	Palier	1.0.4215 020
13	Messerwelle	Knife shaft	Arbre de coupe	1.5.5323 020 1.5.5323.021
14	Falzwalze	Folding roller	Cylindre	1.5.5322 030 with 1.0.5326 010 Stahl-Kunststoff Steel-Plastic Acier-Plastique 1.5.5322 020 Stahl Steel acier
15	Schraube	Screw	Vis	M 8 x 20 DIN 912
16	Welle	Shaft	Arbre	1.5.5221 040
17	Taschenleiste	Buckle bar	Barre à Poches	2.0.5644 010
18	Exzenterbuchse	Excentric bush	Excentrique	2.0.5626 010
19	Klemmstück	Clam	Support	1.0.5115 361
20	Druckfeder	Spring	Ressort	2.0.5681 010
21	Schraube	Screw	Vis	M 5 x 10 DIN 912
22	Transportrolle	Roller	Roulette de Transport	1.0.5339 010
23	Schutzblech	Guard	Protection	1.5.5163 040
24	Schutzblech	Guard	Protection	1.5.5161 020
25	Klemmstange	Holding bar	Barre de serrage	1.5.5121 020
26	Mutter	Nut	Ecrou	1.0.5539 010
27	Distanzscheibe	Distance washer	Rondelle	35 x 45 x 1 DIN 988
28	Messeraufnahme	Knife holder	Porte-Lame cpl.	1.0.5539 020
29	Unterteil	Knife	Lame inférieure	2.0.5539 010
30	Stellschraube	Adjustment screw	Vis	50 370 040
31	Abstreifer	Stripper	Decolleur	1.0.5586 010
32	Schraube	Screw	Vis	M 6 x 10 Umbrako
33	Halter	Holder	Support	60 500 140
34	Rändelschraube	Knurled screw	Vis moletée	M 6 x 12 DIN 653
35	Schneidmesser	Knife	Lame de coupe	2.0.5591 010
36	Rillmesser	Creasing knife	Lame de rainage	2.0.5591 020
37	Perforiermesser	Perforator	Lame de perforage	2.0.5591 030
38	Perforiermesser	Perforator	Lame de perforage	2.0.5591 040

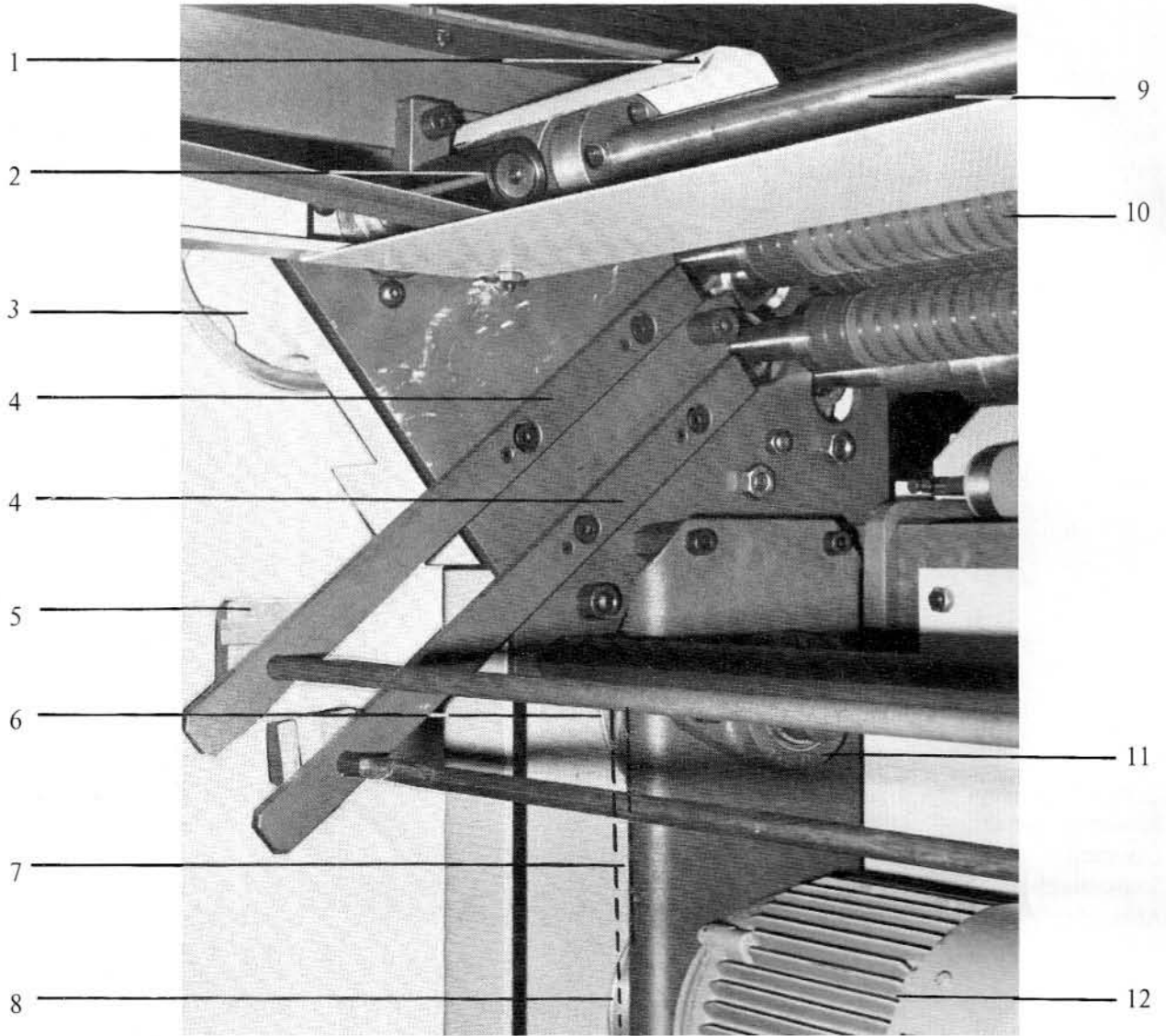

1	Schutz	Guard	Protection	1.0.4163 030
2	Bandrolle	Tape roller	Roulette	F 31643 - 28 x 60 x 70
3	Handrad	Handwheel	Volant	Zi 160 x 16
4	Taschenleiste	Buckle bar	Bande	2.0.5644 010
5	Halter	Holder	Support	1.0.5115 361
6	Federscheibe	Spring washer	Ressort rondelle	F 100 b
7	Keilriemen	V-belt	Courroie trapézoïdale	20 x 550 Li
8	Regelscheibe	Pulley	Poulie variable	R 100 b
9	Welle	Shaft	Arbre	1.5.5221 040
10	Falzwalze	Folding roller	Cylindre	1.5.5322 030 Stahl-Gummi, Steel-Plastic Acier-Plastique 1.5.5322 020 Stahl, Steel, Acier
11	Lager	Bearing	Roulement	RCJTZ 25 INA
12	Motor	Motor	Moteur	0,55 kw

Ersatzteilliste
Spare part list
Manuel pièces de rechange

brass pulley
1.0.5636.010

49 - 55 Falztaschen

buckle plates
Poches

9.956.116

block 1.0.5644.011
brass bushing in
blk 1.0.5616.030

1.5.5621.030 shaft

plastic washer
1.0.5616.041

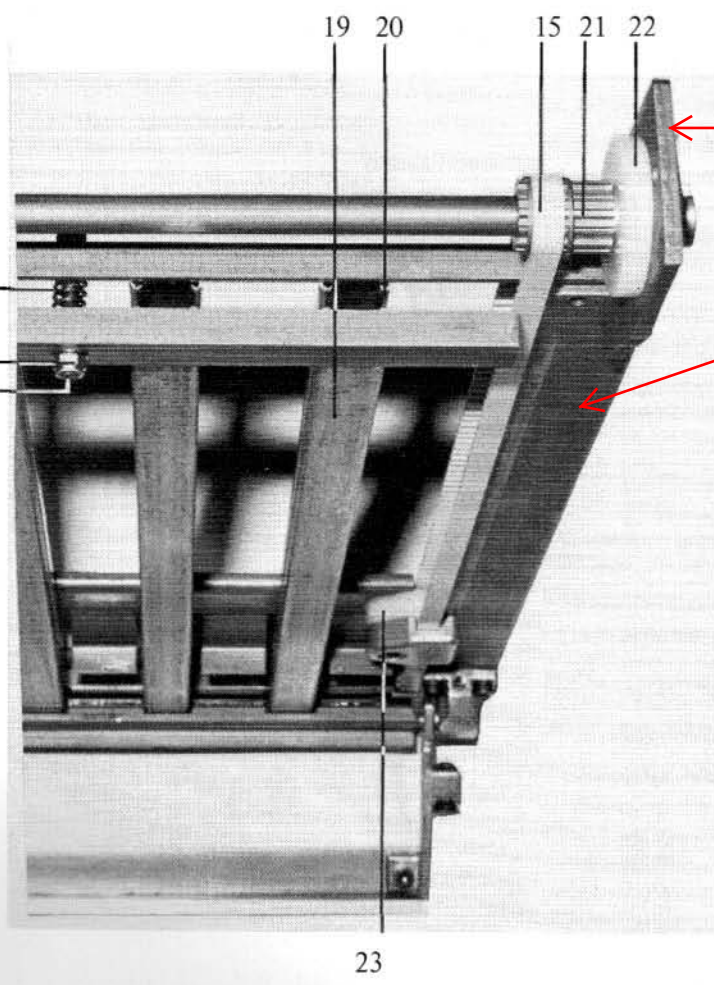
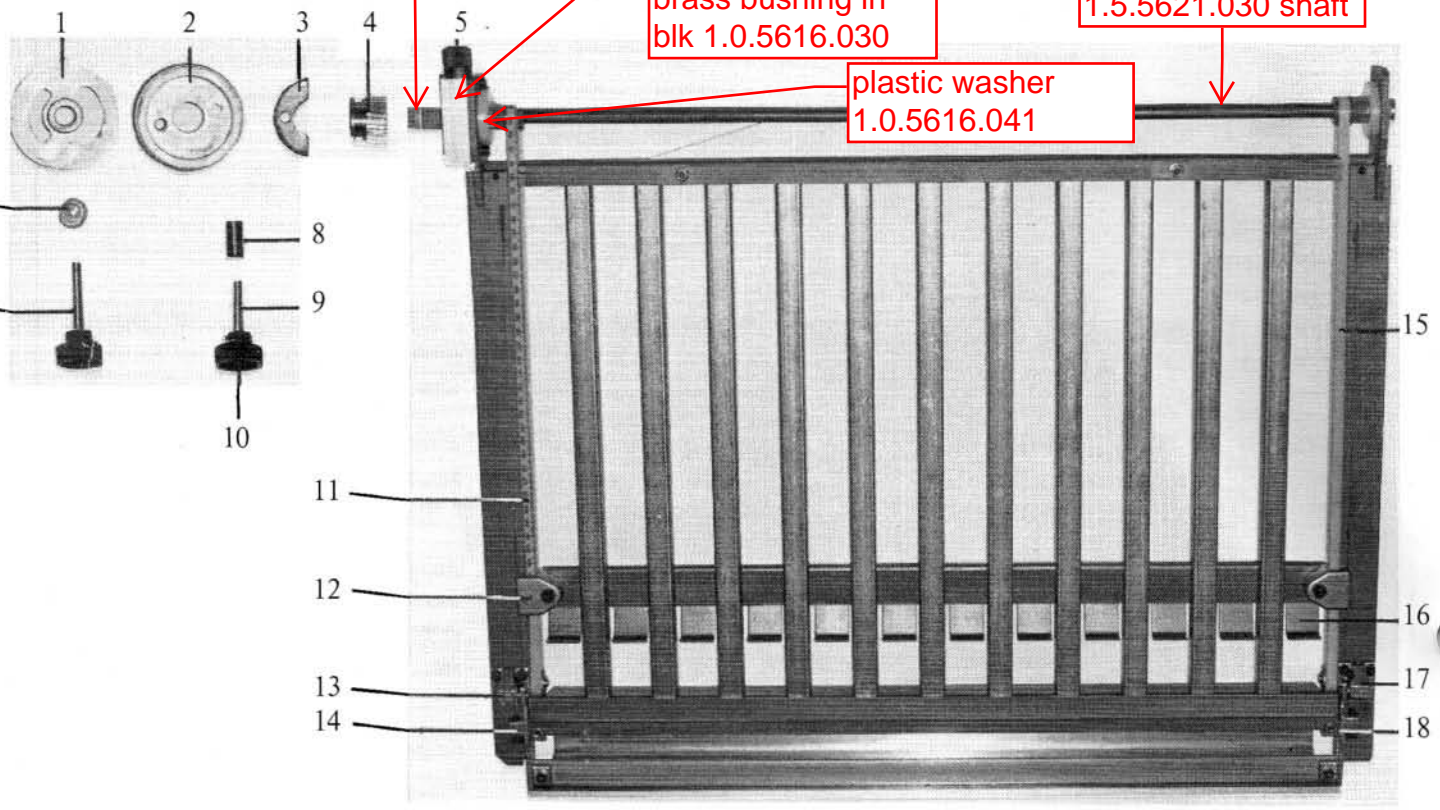

1.0.5664.020 plate holder

1.5.5641.070 bar

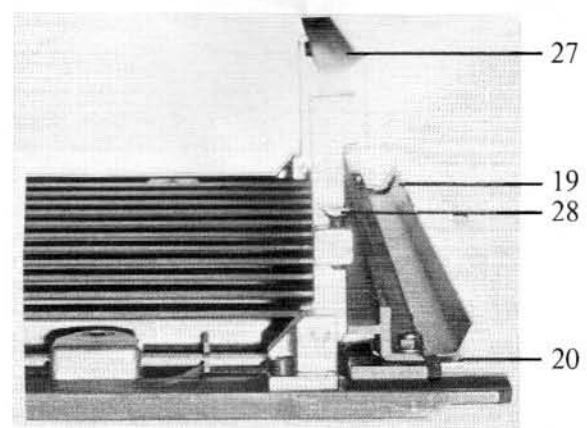

1	Stellscheibe	Adjustment washer	Rondelle de réglage	3.0.5628 020
2	Stellscheibe	Adjustment washer	Rondelle de réglage	3.0.5628 010
3	Segment	Segment	Segment	3.0.5628 030
4	Schneckenrad	Worm wheel	Sans vin	1.0.5637 010
5	Stellschraube	Adjustment screw	Vis de réglage	1.0.5628 010
6	Scheibe	Washer	Rondelle	6,4 DIN 125
7	Rändelschraube	Knurled screw	Vis moletée	M 6 x 28 GN 421
8	Spannhülse	Pin	Distance	10 x 18 DIN 1481
9	Rändelschraube	Knurled screw	Vis moletée	M 6 x 35 GN 421
10	Rändelschraube	Knurled screw	Vis moletée	M 6 x 35 GN 421
11	Zahnriemen	Timing belt	Courroie crantée	
	Falzwerk, Unit, Groupe		Tasche, Buckle, Poche	
1			No. 1	mm 1.0.5695 011
1			No. 2	mm 1.0.5695 021
1			No. 3	mm 1.0.5695 030
2			No. 1 u. 3	mm 1.0.5695 030
1			No. 4	mm 1.0.5695 040
2			No. 2 u. 4	mm 1.0.5695 040
	Falzwerk, Unit, Groupe		Tasche, Buckle, Poche	
1			No. 1	inch 1.0.5695 100
1			No. 2	inch 1.0.5695 110
1			No. 3	inch 1.0.5695 120
2			No. 1 u. 3	inch 1.0.5695 120
1			No. 4	inch 1.0.5695 130
2			No. 2 u. 4	inch 1.0.5695 130
12	Klemmstück	Clamp	Support	2.0.5644 041
13	Halter	Holder	Support	1.0.5615 010
14	Hebel	Lever	Levier	
	Tasche oben	Buckle top	Poche du haut	1.0.5615 030
	Tasche unten	Buckle below	Poche du bas	1.0.5615 020
15	Zahnriemen	Timing belt	Courroie crantée	
	Falzwerk, Unit, Groupe		Tasche, Buckle, Poche	
1			No. 1 u. 2	1.0.5695 080
1			No. 3 u. 4	1.0.5695 070
2			No. 1 u. 4	1.0.5695 070
16	Bogenanschlag	Sheet stop	Butée	1.5.5661 010
17	Halter	Holder	Support	1.0.5615 010
18	Hebel	Lever	Levier	
	Tasche oben	Buckle top	Poche du haut	1.0.5615 020
	Tasche unten	Buckle below	Poche du bas	1.0.5615 030

#19 SINGLE RIB 1.0.5652.330

19	Taschenoberteil	Buckle part top cpl.	Poche du haut-partie superieure	
	Falzwerk, Unit, Groupe	Tasche, Buckle, Poche		
	1	Stabl. = 563	No. 1 u. 2	1.5.5600 300
	1	Stabl. = 403	No. 3 u. 4	1.5.5600 310
	2	Stabl. = 403	No. 1 - 4	1.5.5600 310
20	Taschenunterteil	Buckle part below	Poche du bas-partie superieure	
	Falzwerk, Unit, Groupe	Tasche, Buckle, Poche		
	1	Stabl. = 563	No. 1 u. 2	1.5.5600 400
	1	Stabl. = 403	No. 3 u. 4	1.5.5600 410
	2	Stabl. = 403	No. 1 - 4	1.5.5600 410
21	Zahnscheibe	Washer	Rondelle	1.0.5636 010
22	Scheibe	Washer	Rondelle	1.0.5616 040
23	Klemmstück	Clamp	Pièce de blocage	2.0.5644 051
24	Druckfeder	Spring	Ressort	D 198
25	Mutter	Nut	Ecrou	M 5 DIN 985
26	Schraube	Screw	Vis	M 5 x 35 DIN 912
27	Umlenkstück	Deflector	Déciation	1.5.5641 060
28	Schraube	Screw	Vis	M 6 x 20 DIN 7991

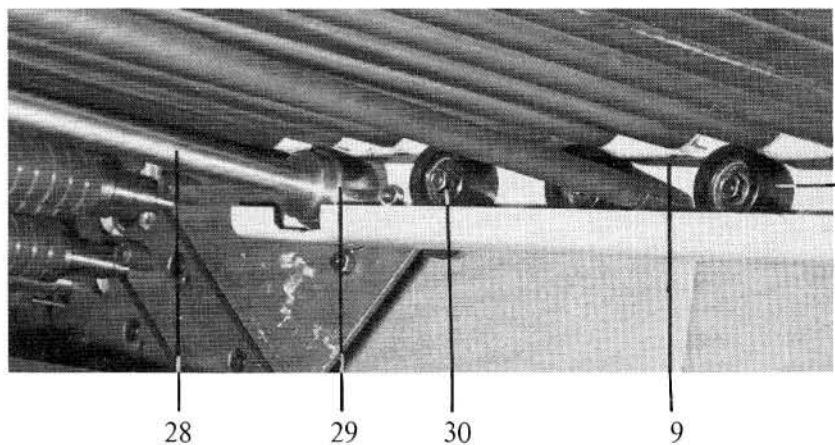
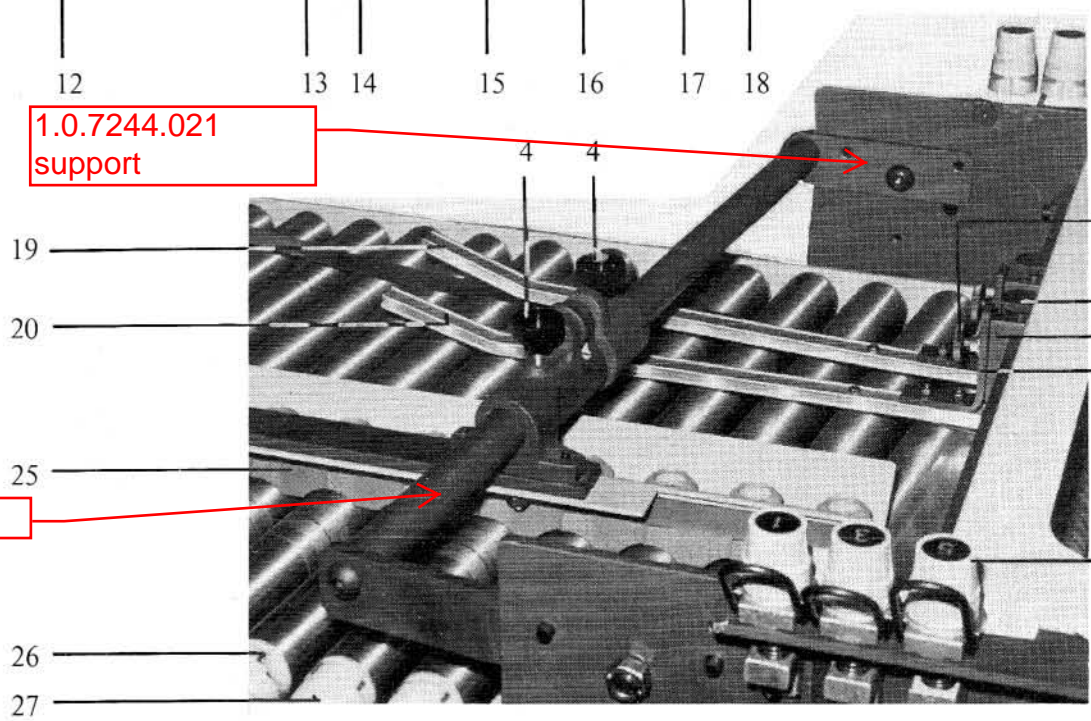
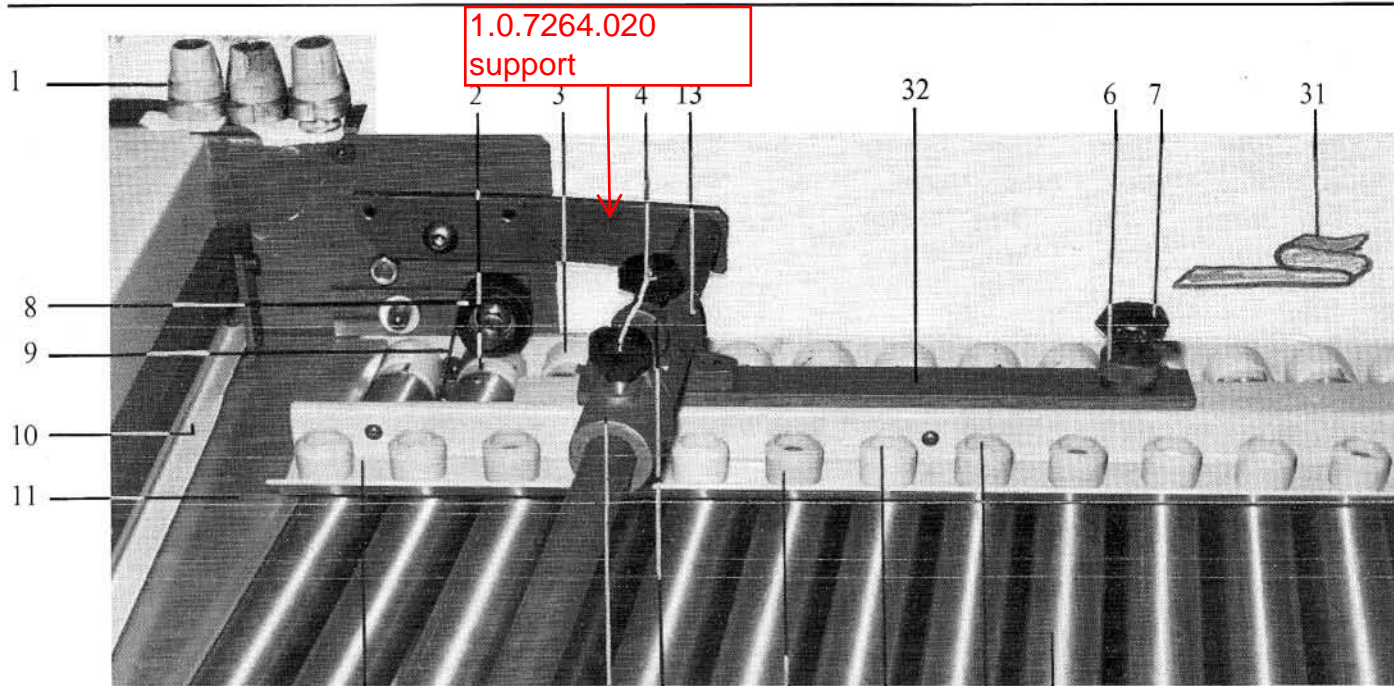

1	Stellmutter	Adjustment nut	Vis de réglage	1.0.5416 010
2	Kupplungsstück	Coupling part	Noix fixe	70 640 010
3	Bandrolle	Tape rolle	Roulette	4.0.7400 020
4	Rändelhohlschraube	Knurled screw	Vis moletée	M 8 x 20 GN 421
5	Stellstück	Adjustment part	Palier	1.0.4215 040
6	Exzentergriff	Excenter grip	Pièce de réglage	10 420 030
7	Sterngriff	Stargrip	Douille plastique	K 40 x M 8
8	Bandrolle	Tape roller	Roulette	INA V 56 202
9	Flachriemen	Flat belt	Cordon	20 x 1 x 2750
10	Schutzblech	Guard	Protection	1.5.5163 040
11	Leitblech	Infeed plate	Tôle d'introduction	1.5.7363 030
12	Kugelleiste	Ball bar	Barre à bille	1.5.7261 020
13	Stellstück	Adjustment part	Palier	1.0.7215 010
14	Rändelmutter	Knurled nut	Ecrou moletée	M 8 DIN 467
15	Kugelbüchse	Ball holder	Porte bille	3.0.7226 010
16	Kunststoffkugel	Plastic ball	Bille plastique	25 ø
17	Stahlkugel	Steel ball	Bille acier	25 ø
18	Schräggrolle	Transport roller	Roulette	1.5.7400 100
19	Niederhalter	Smoother bar	Railde guidage	70 530 050
20	Niederhalter	Smoother bar	Railde guidage	70 530 050 cpl. mit/with/avec
	Blattfeder	Flat spring	Ressort	70 530 070
21	Rändelschraube	Knurled screw	Vis moletée	M 6 x 12 DIN 653
22	Rändelschraube	Knurled screw	Vis moletée	M 6 x 12 DIN 653
23	Halter	Holder	Support	70 500 260
24	Halter	Holder	Support	70 490 390
25	Lineal	Side lay	Règle	1.5.7261 010
26	Kupplungsstück	Coupling part	Noixe fixe	70 640 011
27	Bandrolle	Tape roller	Roulette	4.0.7400 020
28	Welle	Shaft	Arbre	1.5.5221 040
29	Riemenscheibe	Pulley	Poulie	1.0.7332 010
30	Bandrolle	Tape roller	Roulette	INA V 56 202
31	Niederhalter	Smoother bar	Rail de guidage	3.0.7286 010
32	Leiste	bar	Support	2.0.7244 010

1	Schraube	Screw	Vis	M 5 x 10 DIN 912	
2	Stellring	Ring	Rondelle	A 12 DIN 705	
3	Transportband	Tape	Cordon	860 x 560	
4	Kerbstift	Pin	Vis	A 12 x 40	
5	Seegerring	Circlips	Circlips	12 x 1 DIN 471	
6	Bandwalze	Tape roller	Roulette	1.5.8126 020/ 2 x 1.0.8127 010	
7	Rolle	Roller	Rondelle	2.0.8112 010	} cpl. VM 0172
8	Halter	Holder	Support	2.0.8115 020	
9	Niederhalter	Smoother bar	Abat feuille	2.0.8186 020	
10	Rändelschraube	Knurled screw	Vis moleté	M 5 x 20 DIN 653	
11	Halter	Holder	Support	2.0.8115 010	
12	Rolle	Roller	Roulette	2.0.8112 010	
13	Rändelschraube	Knurled screw	Vis moleté	M 5 x 20 DIN 653	
14	Halter	Holder	Support	2.0.8115 030	
15	Leitblech	Infeed plate	Tôle d'introduction	1.5.8161 030	
16	Steckachse	Bolt	Axe	1.0.5325 080	
	Sterngriff	Star grip	Poignée	mit-with-avec K 40 x M 8 DIN 6336	
17	Steckachse	Bolt	Axe	1.0.5325 080	
	Sterngriff	Star grip	Poignée	mit-with-avec K 40 x M 9 DIN 6336	
18	Bandwalze	Tape roller	Roulette	1.5.6426 030 2 x 2.0.5327 010	
19	Motor	Motor	Moteur	0,55 W 40 u/min 24 V = SWF	
20	Schlagtaster	Bottom switch	Bouton	D 1 C 1 R/DA 11	
21	Drucktaster	Bottom switch	Bouton	D 1 A 1 R/DA 11	
22	Drucktaster	Bottom switch	Bouton	D 1 A 1 G/DA 11	
23	Drucktaster	Bottom switch	Bouton	D 1 A 1 B/DA 11	
24	Potentiometer	Potentiometer	Potentiomètre	A 25 K Lin.	